

How to calculate embodied carbon

How to calculate embodied carbon

Acknowledgements

Permission to reproduce the following has been obtained, courtesy of these individuals/organisations:

Front cover image: J J Orr

Data used in Figure 2.4: © OneClick LCA

Published by The Institution of Structural Engineers

International HQ, 47–58 Bastwick Street, London EC1V 3PS, United Kingdom

T: +44(0)20 7235 4535

E: mail@istructe.org

W: www.istructe.org

First published (version 1.0) March 2022

978-1-906335-56-4 (print)

978-1-906335-57-1 (pdf)

© 2022 The Institution of Structural Engineers

The Institution of Structural Engineers and the Task Group which produced this *Guide* have endeavoured to ensure the accuracy of its contents. However, the guidance and recommendations given should always be reviewed by those using the *Guide* in light of the facts of their particular case and any specialist advice. Users should also note that the Institution periodically updates its guidance through the publication of new versions (for minor alterations) and new editions (for more substantial revisions) — and should ensure they are referring to the latest iteration. No liability for negligence or otherwise in relation to this *Guide* and its contents is accepted by the Institution, its servants or agents. **Any person using this *Guide* should pay particular attention to the provisions of this Condition.**

No part of this publication may be reproduced or stored in a retrieval system without prior permission from The Institution of Structural Engineers, who may be contacted at: 47–58 Bastwick Street, London EC1V 3PS, United Kingdom.



Authors (2nd edition: 2022–)

O P Gibbons	MEng (Arup)
J J Orr	MEng(Hons) PhD CEng MStructE FHEA (University of Cambridge)
C Archer-Jones[†]	BEng MSc DIC CEng MStructE MIEAust (COWI)
W Arnold	MEng(Hons) CEng MStructE (The Institution of Structural Engineers)
D Green[†]	CEng MICE (COWI)

Reviewers (2nd edition: 2022–)

J Anderson	BA MSc FRSA (ConstructionLCA Ltd)
S Boote	BEng(Hons) CEng MStructE AMICE (Webb Yates Engineers)
R Boyd	MEng CEng MICE (Arup)
J Burridge	MA CEng MICE MStructE (MPA The Concrete Centre)
A Campbell	BSc MSt CEng MICE (changebuilding)
T Chapman	BE MSc DIC CEng FICE FIEI FEng (Arup)
D Cox	BA (Thornton Tomasetti)
T Ellis	BSc MSc CEnv MEnvSc (Arup)
M Farnetani	MArch MSc ARB BREEAM-AP (Hilson Moran)
B Gholam	CEng MStructE (Price & Myers)
A Girao-Coelho	PhD MSc CEng (British Constructional Steelwork Association)
K Harrison	BEng (Hons) CEng MStructE (Whitby Wood)
M Hasman	RIBA LEED WELL BREEAM AP (SOM)
W Hawkins	MEng PhD (University of Bath)
T Ibell	CEng FEng PhD FStructE FICE FHEA (University of Bath)
S Jagnarine Azan	MSc MStructE DIC (Pan American Health Organization)
D Kestner	PE SE LEED AP BD+C ENV SP (Walter P Moore)
C Law	MIEMA ICIOB CEnv (Timber Development UK)
Q Li	PhD MArch BArch (Cundall)
A Lynes	MA MEng(Hons)(Cantab) CEng MStructE (Webb Yates Engineers)
T Maclean	MA CEng MStructE (Allt Environmental)
E Marsh	MEng GMICE (University of Cambridge)
K Micallef	PhD DIC CEng MICE (SOM)
M Moynihan	CEng MStructE (Laing O'Rourke)
J Norman	MEng PhD CEng MICE FHEA (University of Bristol)
H Pantelidou	PhD MICE CEng (Arup)
A Papakosta	MSc MEng (SCS Railways)
I Poole	MEng (Mott MacDonald)
J Prew	BSc(Hons) CEng MStructE MICE MAPM (Hampshire County Council)
J Ratcliffe	MEng CEng FStructE PE (scale consulting ltd)
W Rogers-Tizard	CEng MStructE (Price & Myers)
T Ronalds	MEng CEng MStructE (Eckersley O'Callaghan)
M Sansom	BEng PhD CEnv MICE (Steel Construction Institute)
S Smith	CEng MStructE (Smith and Wallwork)
K Symons	MEng MA MStructE MICE CEng CPEng CMEngNZ IntPE(NZ) (New Zealand Government)
J Walker	MSc CEng MICE MStructE (Milner Associates)
N Watson	EngD CEng MICE (Buro Happold)
O Woodruff	MEng CEng MICE (Arup)
F Yang	BS MEng SE(CA) (Arup)

Publishing (2nd edition: 2022–)

L Baldwin	BA(Hons) DipPub (The Institution of Structural Engineers)
------------------	---

[†] Appendix C only.

Authors (1st edition: 2020–2022)

O P Gibbons MEng (Arup)
J J Orr MEng(Hons) PhD CEng MIStructE FHEA (University of Cambridge)

Reviewers (1st edition: 2020–2022)

W Arnold MEng(Hons) CEng MIStructE (Arup + The Institution of Structural Engineers)
S Boote BEng(Hons) CEng MIStructE AMICE (Webb Yates Engineers)
R Boyd MEng CEng MICE (Arup)
J Burridge MA CEng MICE MIStructE (MPA The Concrete Centre)
T Ellis BSc MSc CEnv MIEEnvSc (Arup)
M Farnetani MArch MSc ARB BREEAM-AP (Hilson Moran)
B Gholam CEng MIStructE (Price & Myers)
A Girao-Coelho PhD MSc CEng (British Constructional Steelwork Association)
W Hawkins MEng PhD (University of Bath)
T Ibell CEng FEng PhD FIStructE FICE FHEA (University of Bath)
Q Li PhD MArch BArch (Cundall)
A Lynes MA MEng(Hons)(Cantab) CEng MIStructE (Webb Yates Engineers)
E Marsh MEng GMICE (University of Cambridge)
M Moynihan CEng MIStructE (Laing O'Rourke)
A Papakosta MSc MEng (SCS Railways)
I Poole MEng (Mott MacDonald)
J Prew BSc(Hons) CEng MIStructE MICE MAPM (Hampshire County Council)
J Ratcliffe MEng CEng FIStructE PE (scale consulting ltd)
W Rogers-Tizard CEng MIStructE (Price & Myers)
T Ronalds MEng CEng MIstructE (Eckersley O'Callaghan)
M Sansom BEng PhD CEnv MICE (Steel Construction Institute)
K Symons MEng MA MIStructE MICE CEng CPEng CMEngNZ IntPE(NZ) (New Zealand Government)
N Watson EngD CEng MICE (Buro Happold)
F Yang BS MEng SE(CA) (Arup)

Publishing (1st edition: 2020–2022)

L Baldwin BA(Hons) DipPub (The Institution of Structural Engineers)
L Woodward BSc PGCE (Editorial & Academic Services)

Contents

Foreword	v
Purpose, principles and impact	vi
1 Introduction to carbon calculations	1
1.1 Life cycle stages and modules	1
1.2 Terminology	2
2 Calculating embodied carbon	4
2.1 Minimum scope of calculation	5
2.1.1 Minimum scope: life cycle stages and modules	5
2.1.2 Minimum scope: building elements	5
2.2 Inputs	7
2.2.1 Material quantities	8
2.2.2 Modules A1–A3 carbon factors	9
2.2.3 Module A4 carbon factors	19
2.2.4 Module A5 carbon factors	21
2.2.5 Stages B and C carbon factors	24
2.2.6 Module D carbon factors	28
2.3 Process	31
2.3.1 Calculation	31
2.3.2 Normalising results	34
2.3.3 Sense check	35
2.3.4 Uncertainty	35
2.3.5 Communicate and discuss embodied carbon	36
2.3.6 Calculation tools	39
2.3.7 Reducing embodied carbon	39
2.4 Outputs	41
2.4.1 Reporting publicly	41
2.4.2 As-built calculation	42
2.4.3 Share case studies	42
3 Conclusions	43
Appendix A: Carbon factor databases	44
Appendix B: Example calculation	46
Appendix C: Supplementary information for bridges	50
References	55

Foreword

This document supports legislation by UK Parliament to achieve net zero carbon emissions by 2050 and forms a part of the response of The Institution of Structural Engineers to implement the necessary changes in the profession to respond to the climate emergency.

Naturally, the materials that structural engineers specify must be used efficiently to create structures that are safe and durable. But it is now abundantly clear that structural engineers need to reduce the harm that manufacture and disposal of these materials cause our planet's ecosystem, which accounts for 11% of global greenhouse gas emissions. Hence, we must reduce the embodied carbon of the structures we design.

Structural engineers need an agreed set of principles for the measurement of embodied carbon to be able to make meaningful comparisons and carbon reductions across the construction industry. This will allow us to set agreed carbon target levels for structures and track the level of reduction in embodied carbon, to ensure we achieve net zero carbon by 2050.

Being able to measure and compare embodied carbon of structures is only one step in the quest for the decarbonisation of the construction industry. Yet it is an important step because it allows us to place 'embodied carbon' alongside 'embodied costs' in the design of structures — managing carbon footprint through material selection and specification, material reuse, lean design and waste reduction. An ability to quantify the benefits of low carbon design to the client and society and ensure we meet targeted reductions is crucial for the future.

This guidance will help inform structural engineers, and the professionals with whom they collaborate, about ways they can move towards net zero carbon design. The need is becoming increasingly urgent and the consequences of failure are increasingly alarming.



Dr Mike J Cook
IStructE Climate Emergency Task Group Chair
August 2020

Purpose, principles and impact

Purpose

This guide provides a common set of embodied carbon calculation principles for the structural engineering community to follow. The imperative to achieve net zero carbon by 2050 must change the way we practice — and calculating carbon is a key part of this.

Calculating embodied carbon in the same rigorous way across all designs will allow meaningful comparisons to be made between structural schemes, developing our understanding of embodied carbon as well as how we can most effectively reach net zero carbon. This guidance is equally applicable to infrastructure and building projects.

The calculation of embodied carbon must become a key part of every design process. Such efforts support our immediate need to reduce resource demand and increase reuse and recycling to enable a circular economy.

This guide builds on the IStructE's portfolio of guidance documents, FAQs and articles related to embodied carbon¹, a topic that has long been on the agenda of some pioneering members of the IStructE community. It supports the sustainability related core tasks in *The Structural Plan of Work 2020*². Implementation of this guide is supported by *The Structural Carbon Tool* (a freely available Excel calculation tool)³, and designs can be rated using the *Structural Carbon Rating Scheme (SCORS)*⁴.

References to embodied carbon data and guidance in this document are UK-focused. Where the authors are aware of such information from other countries, it is referenced in Appendix A. This document is aligned with BS EN 15978⁵, BS EN 15804⁶ and RICS Professional Statement *Whole life carbon assessment for the built environment*⁷.

Principles

We must:

- Achieve net zero carbon⁸ before 2050 (with a 40% reduction in embodied carbon by 2030)
- Calculate embodied carbon[†] on all projects
- Recognise carbon as one component of sustainability
- Evaluate design decisions against their carbon impact
- Communicate carbon insights to the project team and client
- Advocate and engage the project team to find ways to reduce carbon impacts
- Report module-based^{††} carbon data to an open-source database

⇒ Suggestions, hints, common pitfalls and tips are captured in red boxes.

Key principles are contained within green boxes.

Grey boxes highlight the end of a process or calculation stage.

[†] As a minimum, we must calculate 'upfront' carbon emissions (life cycle Modules A1–A5, as explained in Section 1.1 and Figure 2.2).

^{††} Module D must always be reported separately to Stages A–C.

Impact

It is important to realise the scale of impact that our professional activities have on the climate. Buildings and construction presently account for around 40% of energy-related CO₂ emissions globally. Deep changes across the design, construction, use and reuse of buildings and infrastructure are required if we are to have any chance of providing a sustainable environment for the 9.7bn people, including 6.5bn city dwellers, who will share our planet in 2050.

Figure 0.1 contextualises the scale of opportunity the average structural engineer has to reduce carbon emissions in comparison to the impact the average citizen may have by making a significant environmentally-conscious change to their personal lives.

Figure 0.1: Contextualising potential impact of structural engineers[†]



Analysis of recently constructed buildings has demonstrated that material inefficiencies in the order of 50% are common⁹. Overdesign of buildings and infrastructure must also be tackled to reduce material demand and to help meet carbon targets.

One route to zero carbon structural design is through the reuse and life extension of existing buildings and their component parts. ‘Building nothing’ while meeting your client’s brief requires much thought and engineering analysis but is essential if we are to dramatically cut carbon emissions. You should resist demolition wherever you can and ensure reuse in some form as a key part of every design you create. End of life discussions are thus an integral part of achieving a circular economy.

[†] 20% structural embodied carbon reduction achieved is based on the assumption of a structural engineer being responsible for (on average) 5,000m² development per year, at an average A1–A5 emissions of 200kgCO₂e/m² (substructure and superstructure) and achieving embodied carbon reductions of 20% (i.e. reduction of 40kgCO₂e/m²). Values approximated. Return flight to New York including radiative forcing calculated using <https://carbon.tips/calc>. Impact of diet is an approximate value assuming a saving each week of 1–2 portions each of beef, chicken, lamb and fish, 7 × 200ml portions of dairy milk and 7 pints of beer, calculated using <https://carbon.tips/diet>. Driving emissions calculated assuming 10,000 miles per year in an average petrol car, using <https://carbon.tips/calc>.

1 Introduction to carbon calculations

1.1 Life cycle stages and modules

To help describe the environmental impact of an asset, its life cycle is split into stages and modules as defined by BS EN 15978⁵ for buildings (Figure 1.1a) and PAS 2080¹⁰ for infrastructure (Figure 1.1). The environmental impact this guidance refers to is carbon dioxide equivalent emissions (kgCO₂e) – refer to Section 1.2.

An example split of low-energy residential building emissions for Modules A1–C4 is shown at the base of Fig. 1.1a, using example data from LETI’s *Embodied Carbon Primer*¹¹ across all building elements for a medium-scale residential building. This highlights the significant contribution of Modules A1–A3 to the total embodied carbon.

Remember that efforts to calculate, report and reduce embodied carbon should be taken in conjunction with wider discussions about the whole life performance of built assets along with emissions from land use change. Embodied carbon is just one piece of the sustainability puzzle.

Figure 1.1: a) BS EN 15978⁵ Life cycle stages. Example split of emissions from Modules A1–C4 shown at bottom, using example data across all building elements for a medium-scale residential building. Operational carbon modules outlined in red. b) Additional modules defined in PAS 2080¹⁰ for infrastructure projects

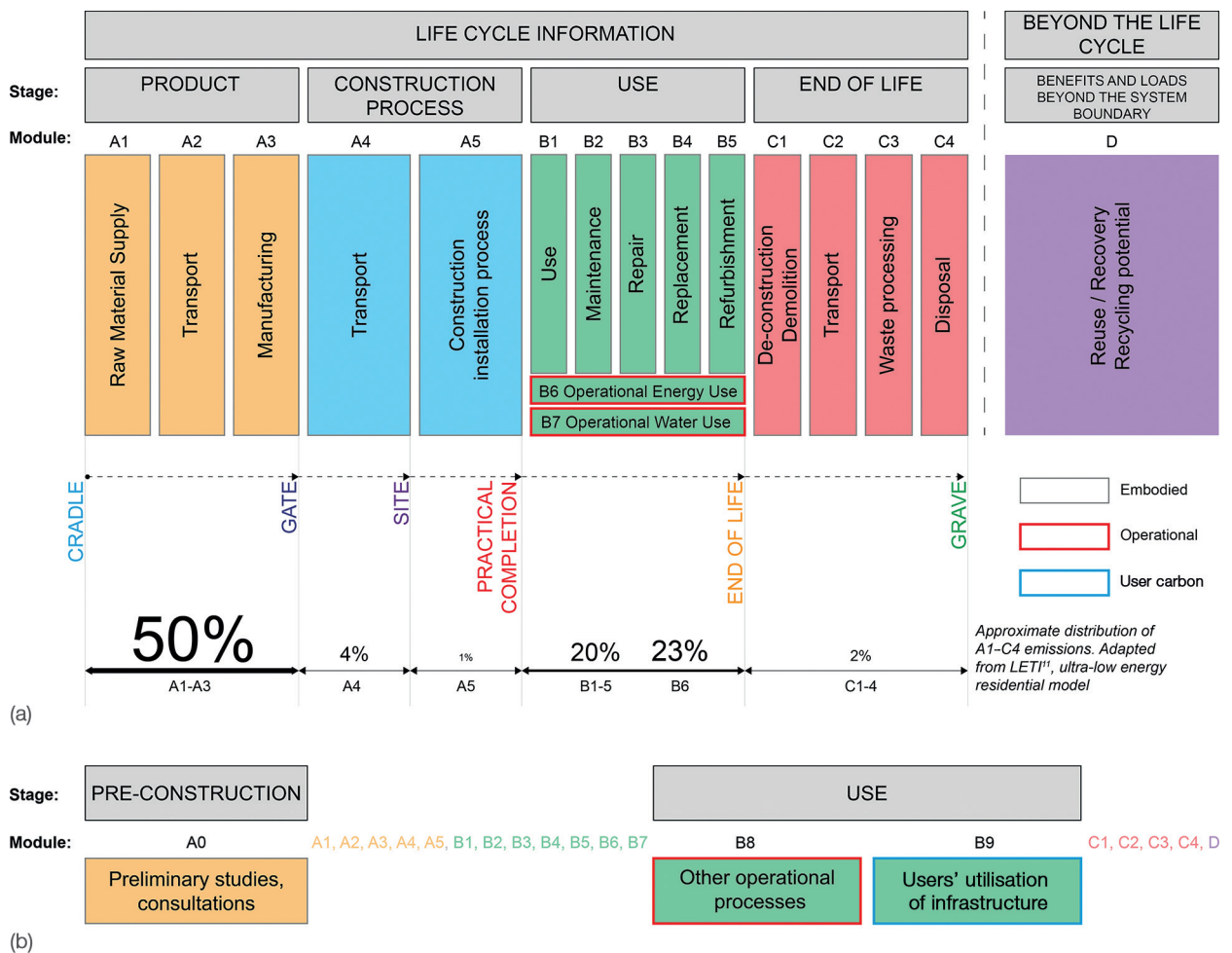

There are four life cycle stages:

1. **Product stage** (also known as 'cradle to gate'). Modules A1–A3. kgCO₂e released during extraction, processing, manufacture (including prefabrication of components or elements) and transportation of materials between these processes, until the product leaves the factory gates to be taken to site. Note that recycled content of a product affects the kgCO₂e released in Modules A1–A3. Whether it is recycled after its end of life or not, the A1–A3 impact of the project being considered is not affected — this is taken into account in Module D.
2. **Construction process stage**. Modules A4 and A5. kgCO₂e released during transport of materials/products to site, energy usage due to activities on site (site huts, machinery use etc.) and the kgCO₂e associated with the production, transportation and end of life processing of materials wasted on site.
3. **Use stage**. Modules B1–B7. kgCO₂e released due to use, maintenance, repair, replacement, refurbishment and operational energy and water while the building is in use. Module B4 (replacement) is often the focus of the use stage when embodied carbon is being considered.
4. **End of life stage**. Modules C1–C4. kgCO₂e released during decommissioning, stripping out, demolition, deconstruction, transportation of materials away from the site, waste processing and disposal of materials.

There is one additional module beyond the life cycle of the asset that is intended to provide a broader view of its environmental impacts:

- **Module D**. Benefits and loads beyond the system boundary. This estimates any net kgCO₂e benefits or loads beyond the project's life cycle associated with:
 - recycling of materials, e.g. use of scrap steel (rather than virgin iron) in steelmaking on future projects
 - energy recovered from materials, e.g. energy generated by incinerating timber products
 - full reuse of materials/productswhen compared to the standard practice/standard product it would be replacing

1.2 Terminology

This section presents terminology commonly used in industry, and thus aligns with the terminology used throughout this guide. Note that the terms are not always used consistently across all built environment publications. The IStructE's *Climate jargon buster*¹ and WLCN's *Improving Consistency in Whole Life Carbon Assessment and Reporting*¹² are useful sources of further information.

Building component: A prefabricated assembly of materials that form a product with a specific function, e.g. a precast concrete floor unit, a facade unit.

Building element: A major physical part of a building that fulfils a specific function/s, irrespective of its design, specification or construction, e.g. floors, frame, external walls¹⁰.

CEN/TC 350 Sustainability of construction works: The technical committee responsible for the development of standardised methods for the assessment of sustainability aspects of new and existing construction works, and for standards for the Environmental Product Declarations (EPDs) of construction products (Figure 1.2).

kgCO₂e: Carbon dioxide equivalent emissions, often referred to as 'carbon' for short. This measure considers other greenhouse gas emissions (GHGs) in addition to carbon dioxide (CO₂), expressing them in terms of CO₂ normalised by their global warming potential (GWP).

Carbon factor: The kgCO₂e per unit of product, often with units of kgCO₂e/kg or kgCO₂e/m³.

Environmental Product Declaration (EPD): An independently verified and registered document that communicates transparent and comparable information about the life cycle environmental impact of products.

Upfront carbon (kgCO₂e): The GHG emissions associated with materials and construction processes up to practical completion (Modules A1–A5). Upfront carbon excludes the biogenic carbon sequestered in the installed products at practical completion¹².

Embodied carbon (kgCO₂e): The total GHG emissions and removals associated with materials and construction processes throughout the whole life cycle of an asset (Modules A1–A5, B1–B5, C1–C4)¹².

Capital carbon: The term for embodied carbon adopted in the infrastructure sector. PAS 2080 defines the term as ‘greenhouse gas emissions associated with the creation, refurbishment and end of life treatment of an asset’.

Operational carbon (kgCO₂e): The carbon dioxide associated with the in-use operation of the building (Modules B6 and B7). This usually includes carbon emissions associated with heating, hot water, cooling, ventilation and lighting systems, as well as those associated with cooking, equipment and lifts, i.e. both regulated and unregulated energy uses¹⁴.

Regulated energy: Energy consumed that is within the scope of building regulations.

Unregulated energy: Energy consumed that is outside the scope of building regulations.

User carbon: GHG emissions relating to users’ utilisation of infrastructure, and the service it provides during operation.

Whole life carbon (kgCO₂e): The sum total of all asset-related GHG emissions and removals, both operational and embodied over the life cycle of an asset including its disposal (Modules A1–A5, B1–B7 ((plus B8 and B9 for infrastructure only)) and C1–C4). Overall whole life carbon asset performance includes separately reporting the potential benefit from future energy recovery, reuse, and recycling (Module D).

Net zero whole life carbon: Where the sum total of all asset-related GHG emissions, both operational and embodied, over its life cycle (Modules A1–A5, B1–B7, C1–C4) plus offsets equals zero¹³. Minimising emissions should always be prioritised over offsetting.

Figure 1.2: Relationship between selected documents developed by CEN/TC 350

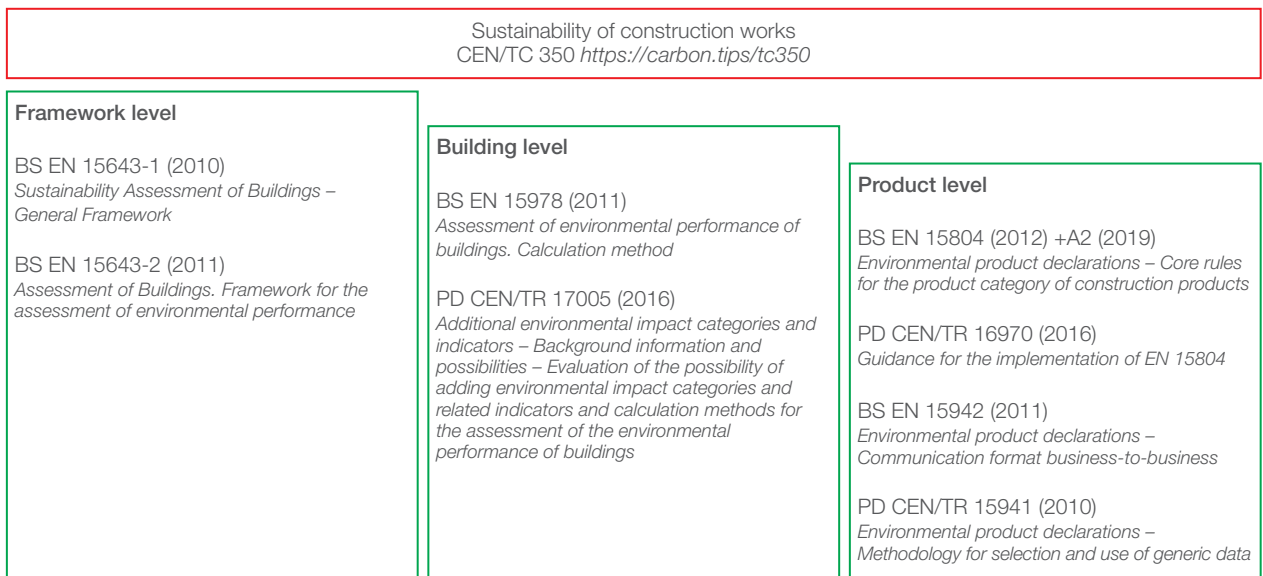

2 Calculating embodied carbon

The fundamental principle of an embodied carbon calculation is to multiply the quantity of each material by a carbon factor for the life cycle modules being considered[†]:

$$\text{material quantity (kg)} \times \text{carbon factor (kgCO}_2\text{e/kg)} = \text{embodied carbon (kgCO}_2\text{e)}$$

Use embodied carbon as a key design metric and communicate findings to your design team members whenever there is a significant design decision to be made, and at project milestones.

The most important time to calculate embodied carbon is in the early design stages. The earlier the better. It is crucial to have time and scope to make changes in light of your embodied carbon assessment.

At the end of each project, report embodied carbon data to an open-source database (Section 2.4.1), and submit lessons learned to *The Structural Engineer* magazine¹⁵. Figure 2.1 outlines how such calculations can be integrated into any stage of a typical project. Items in green boxes are the main focus of this guidance.

Figure 2.1: Calculating embodied carbon – process overview

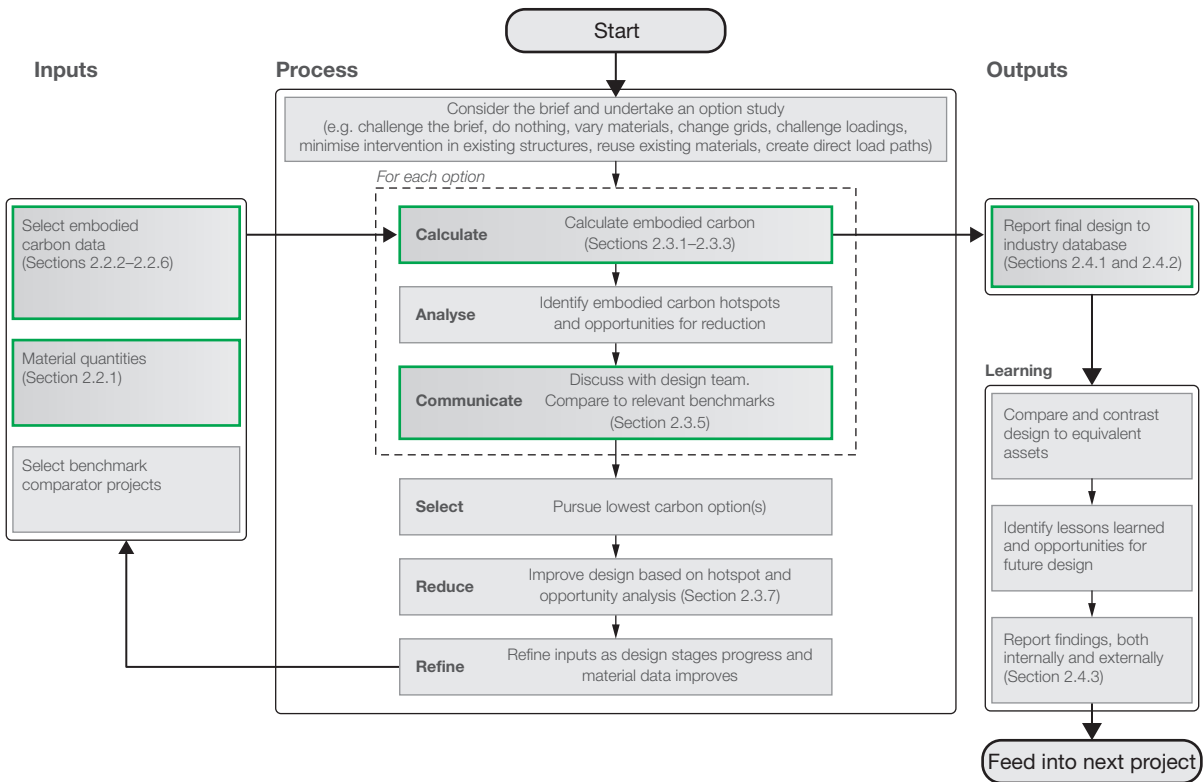

[†] The equation shown applies to materials measured in kg, where a carbon factor in kgCO₂e/kg is available. Any measure of quantity may be used, e.g. m², m³, etc., as long as it corresponds to the units of the carbon factor, e.g. kgCO₂e/m², kgCO₂e/m³, etc. If the unit of quantity does not correspond to the unit of the carbon factor (e.g. quantity in m³, carbon factor in kgCO₂e/kg), the quantity should be adjusted, based on the physical properties of the product, so that its units align with those of the carbon factor, or *vice versa* (e.g. by using the density, kg/m³). For structural materials, carbon factors are commonly shown in kgCO₂e/kg.

2.1 Minimum scope of calculation

As a minimum for structural elements, your calculation should include Modules A1–A5 for primary substructure and superstructure elements.

2.1.1 Minimum scope: life cycle stages and modules

This guide stipulates that the minimum life cycle scope of embodied carbon assessments for structural elements is to include life cycle Modules A1–A5 (embodied carbon to practical completion). There are several reasons for this:

- A1–A5 emissions will be released before 2050. They are therefore the emissions we most urgently need to understand and minimise to keep global warming within 1.5°C
- We have most certainty over A1–A5 emissions data
- Typically, the majority of the embodied carbon of structures is associated with Modules A1–A5, therefore this should be the focus of our carbon reduction efforts

However, best practice is to consider whole life embodied carbon (Stages A–C plus D), so that we not only minimise embodied carbon emissions today but also consider the future emissions impacts of using the asset, durability, longevity, end of life scenarios, reusability and recyclability. This will ensure that future emissions and resource consumption are also kept to a minimum. If Stages A–C are calculated, it is important to report A1–A5 results alongside A–C results.

Be aware that design for minimum upfront carbon can run counter to discussions on future flexibility. Where design teams are advocating longer spans, or higher floor loading, use your carbon calculations to quantify the environmental impact of such choices. You will need to weigh up the certainty of an increase in carbon emissions *today* with the probability of a future change in use, based on the local context. Changes in use may be achieved by means other than building-in extra upfront capacity; for example, by being flexible about what an office space or residential space really needs, or by appropriately designed strengthening works applied in the future. The same discussions should occur when demountable or reusable component design is discussed. A key challenge today is the reuse and life extension of existing buildings.

Note that the RICS Professional Statement *Whole life carbon assessment for the built environment*⁷ states that the minimum scope for a whole building carbon assessment is Modules A1–A5 + B4 (for facades) + B6. This guidance aligns with that document, as Modules B4 and B6 rarely need to be considered in a structural design.

2.1.2 Minimum scope: building elements

This guide stipulates that the minimum building element scope of embodied carbon assessments for structural elements is to include primary structural elements within the substructure and superstructure. You should also calculate the embodied carbon associated with all other elements within your scope of works, and those that enable elements in your scope to meet their performance requirements (e.g. fire protection, vibration damping, temporary works, additional material that might be placed as part of the construction process etc.).

For buildings, the Building Cost Information Service's (BCIS) *Elemental Standard Form of Cost Analysis (SFCA)*¹⁶ summarised in Table 3 of RICS' *Whole life carbon assessment for the built environment*⁷, are used to categorise elements included in a carbon assessment. For a structural engineer, the building element categories most likely to be included in an embodied carbon calculation are given in Table 2.1 of this guidance, with the minimum scope highlighted in green.

⇒ Table 2.1 (right hand column) suggests a way to categorise structural elements included in your calculation to allow better insights into where the embodied carbon lies, and thus how to minimise it. If you do categorise elements in a different way to the BCIS SFCA categories, show how they relate in your design reports, for transparency with other disciplines.

Table 2.1: BCIS SFCA¹⁶ building element categorisations relating to structural elements, mapped against a possible way of breaking down structural elements for carbon analysis. Minimum scope of calculation highlighted in green

Building part/element group (BCIS SFCA)	Building element (BCIS SFCA) ^a	Possible breakdown of structural elements for carbon analysis
0	Facilitating works	0.2 Major demolition works
		0.3 Temporary support to adjacent structures
		0.4 Specialist ground works
1	Substructure	1.1 Substructure
		Foundations (including pile caps)
		Ground-bearing slab
2	2.1 Frame	Basement retaining walls
		Columns
	2.2 Upper floors	Braces
		Beams
	2.3 Roof	Slabs (incl. permanent formwork)
		Roof beams
	2.4 Stairs and ramps	Roof slab
		Stairs and ramps
Structural external walls		
2.5 External walls	Structural internal walls	
	2.7 Internal walls and partitions	
6	Prefabricated buildings and building units	6.1 Prefabricated buildings and building units
7	Work to existing building	7.1 Minor demolition and alteration works

Notes:

^a There are elements within these BCIS SFCA building element categories that do not provide a structural function. Complete category list can be found in Table 3 of RICS' *Whole life carbon assessment for the built environment*⁷.

For the embodied carbon of structural schemes to be meaningfully compared, you should:

- Include in your calculation materials that are designed to ensure the structure meets its performance requirements in different scenarios; e.g. fire protection, waterproofing and damping mechanisms to limit vibration, even if not part of the structural design scope of works. Modules A1–A3 embodied carbon factors for common fire protection materials are given in Table 2.3 so that they can be included in your assessment
- Consider whether any other building elements are influenced by the structural system. Liaise with the wider design team to understand what these may be. Considering whole life and whole building carbon emissions requires collaboration across the project team, which this guide strongly advocates. Although structural engineers need to be fluent in the embodied carbon of structures to contribute to achieving a net zero-emissions built environment, we must not lose sight of how our designs affect emissions associated with the work of other disciplines

⇒ Coordinate assessments across teams to ensure you know who is responsible for which building elements. Your scope of calculation should at least reflect what you are responsible for designing, and this should be clearly reported.

2.2 Inputs

The inputs described in Table 2.2 need to be obtained to calculate embodied carbon for the respective life cycle modules.

Table 2.2: Inputs required for embodied carbon assessments

	Input required	Life cycle module	Section reference
Inputs required for A1–A5 (to practical completion)	Material or product quantities	All stages	Section 2.2.1
	A1–A3 carbon factors	A1–A3	Section 2.2.2
	Distance and mode emissions intensity of transportation of materials to site	A4	Section 2.2.3
	On site material wastage rates	A5	Section 2.2.4.1
	Site activities emissions	A5	Section 2.2.4.2
Additional inputs for A–C (over the life cycle)	Building element replacement cycle	B4	Section 2.2.5.1.1
	Asset lifespan (reference study period)	B4	Section 2.2.5.1.1
	Demolition and deconstruction emissions	C1	Section 2.2.5.2.1
	Distance and mode emissions intensity of transportation of materials away from site	C2	Section 2.2.5.2.2
	End of life scenarios	C3 and C4	Section 2.2.5.2.3
Additional inputs for A–D (whole life carbon)	End of life scenarios	D	Section 2.2.6
	Difference between A1–A3 carbon factors of the secondary product and the substituted product	D	Section 2.2.6

Sections 2.2.1–2.2.6 describe how to obtain these inputs (with references to relevant sources of information), and how to create a carbon factor for each of the life cycle modules within the scope of your embodied carbon assessment. Note that this guidance focuses on UK references. However, the same principles apply to embodied carbon calculations globally.

For Stage B, we focus on B4 (replacement) as:

- Module B1 (use) is generally insignificant for structural materials
- Very little data exists for Modules B2 (maintenance) and B3 (repair)
- Module B5 (refurbishment) refers to planned changes in use defined at the start of the project
- Modules B6 and B7 address operational carbon and are outside the scope of this guide

Section 2.2.5.1 contains more detail on Stage B modules.

2.2.1 Material quantities

Figure 2.2: Calculating embodied carbon – process overview

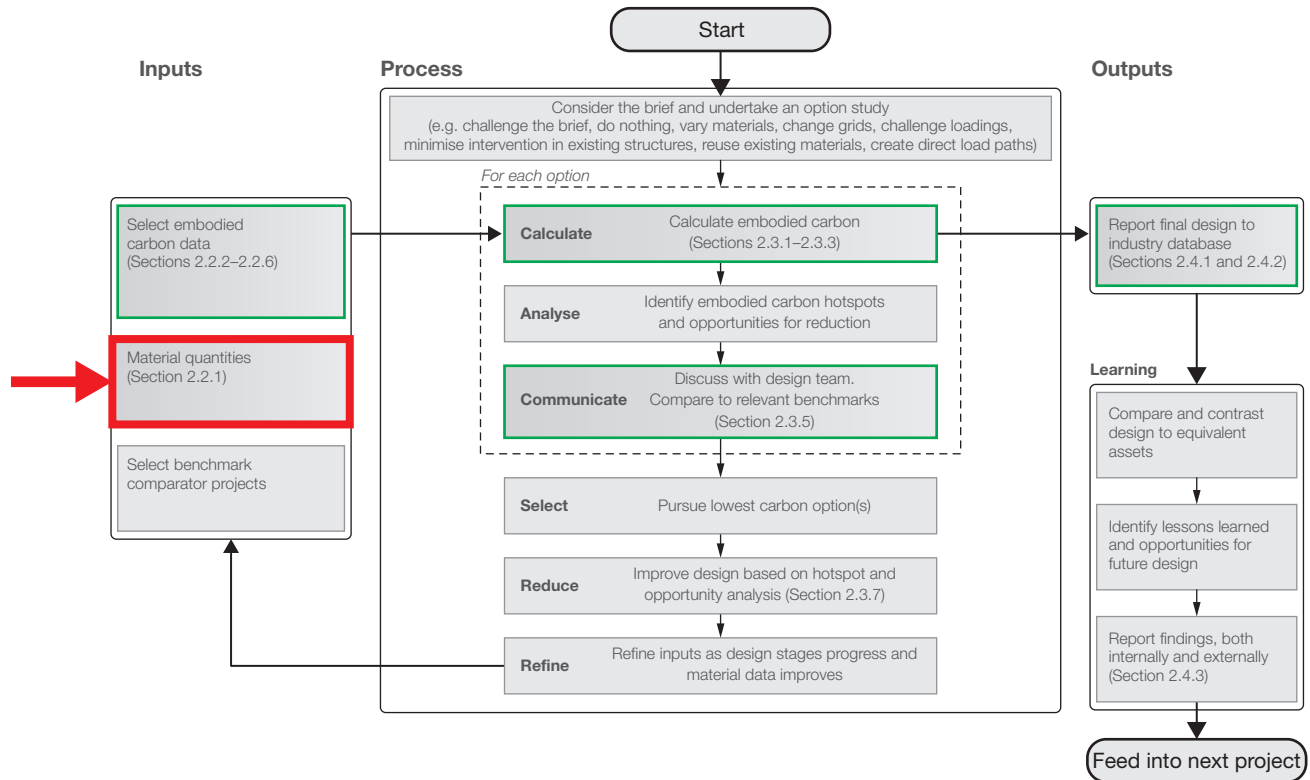

DO NOT be deterred from calculating embodied carbon at early design stages because of uncertainty in material quantities.

Material quantity reduction should always be your primary objective, followed by appropriate specification. This guide does not address material specification writing, but more discussion on this topic can be found in *The Structural Engineer*¹⁷.

Material quantities[†] can be calculated in a number of different ways, depending on the stage of design and the tools available, including:

- Manual calculations
- BIM models
- Structural analysis models
- Scheming manuals (e.g. *Structural Engineer's Pocket Book: Eurocodes*¹⁸)
- Preliminary calculations on representative/repeated structural elements
- Previous project experience
- A quantity surveyor's cost plan^{††}

Uncertainty in material quantities will decrease over the course of a project. Update your calculations regularly to reflect this.

[†] The carbon data you use may dictate how you report your quantities, whether it is in kg, m² or m³. Use material properties to toggle between these different measures as needed.

^{††} Obtaining quantities from the quantity surveyor's cost plan is the least favourable option in terms of being able to feed embodied carbon information into the design process, as there is a time lag between designing and receiving this information to calculate embodied carbon.

- ⇒ Make sure you capture common elements that are often only partially modelled but need to be included in the carbon count: paint and intumescent coverings, piles and footings, concrete blinding, connections (for steel frames a % allowance is usually made), bolts, studs, permanent decking or formwork, rebar laps, etc. Check the specification against your material lists.
- ⇒ Use quantities collected during construction to create an as-built carbon assessment and compare to design calculation.
- ⇒ It is best practice to report material quantity data alongside embodied carbon calculations to aid transparency.

Now you have a list of materials and their quantities (usually in kg or m³).

2.2.2 Modules A1–A3 carbon factors

Modules A1, A2 and A3 are very likely to constitute the majority of structural embodied carbon over the life cycle of a project.

Figure 2.3: Calculating embodied carbon — process overview

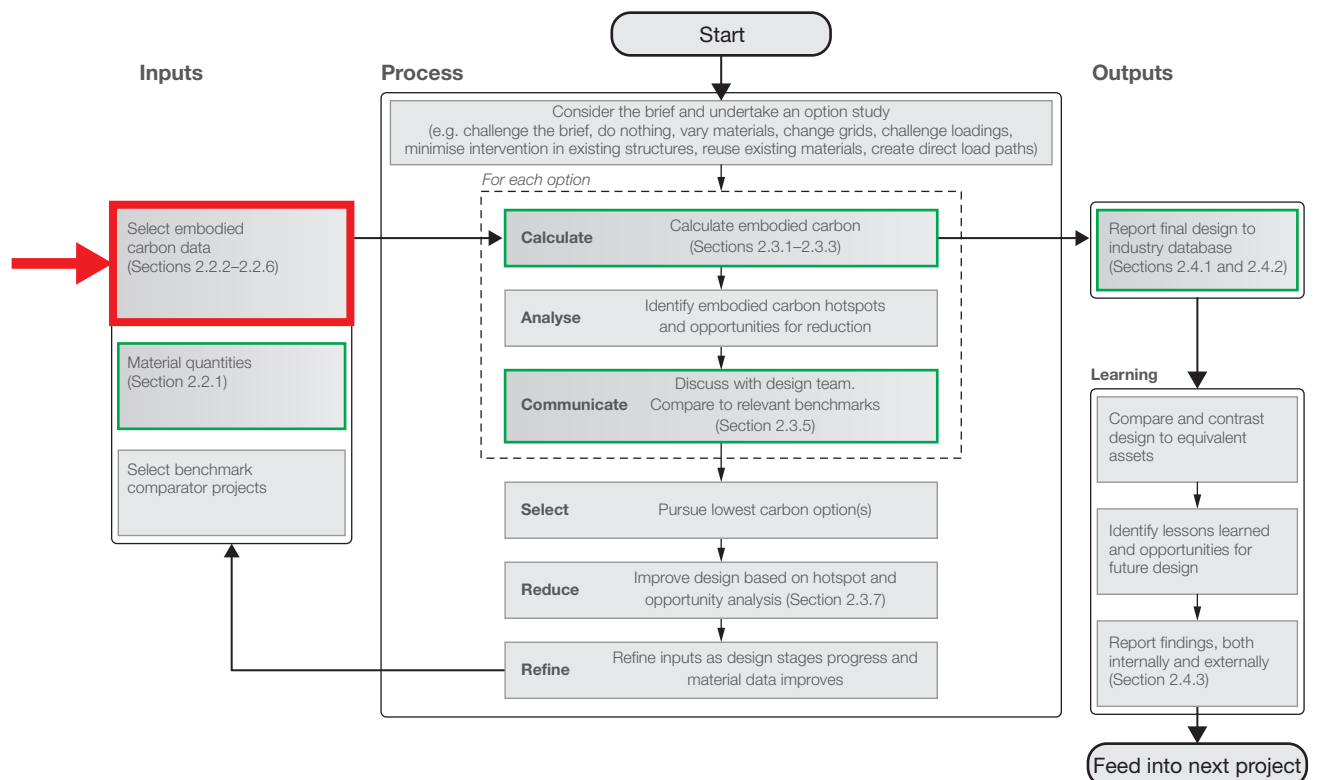

The A1–A3 carbon factor[†] depends on:

- Location where the project will be constructed (when using consumption or production average values for a region or country)
- Location where the products/components are to be manufactured (when supply chain is better understood and component origin is known)
- The material specification

The range in A1–A3 embodied carbon factors can be large. For example, the A1–A3 carbon factor for reinforcement bar could be as low as 0.395kgCO₂e/kg, or as high as 3.97kgCO₂e/kg depending on scrap content and production route (Section 2.2.2.4). To get the most accurate carbon assessment and therefore make the best decisions, at the start of a project, ask your client or a local contractor how they normally source their materials. If you are unable to determine this, use the default values in Table 2.3.

There are a number of different sources of material carbon factors. Some express industry averages for a supplier, a group of suppliers or for a country. Others express the embodied carbon of a specific product.

- ⇒ Choose a factor that best reflects your understanding at the time of calculation, for the source and specification of the material. In the early design stages, this usually means selecting regional or industry average carbon factor data, such as those outlined in Table 2.3. Flag your uncertainty, be transparent about any assumptions made and revisit your choice of A1–A3 carbon factors at later design stages.
- ⇒ Adopting a bounding approach by considering likely minimum, average and maximum carbon factors for each material can be useful to demonstrate the possible range in embodied carbon for your project.

DO NOT be deterred from calculating embodied carbon at early design stages because of uncertainty in carbon factors.

The *Inventory of Carbon and Energy*¹⁹, commonly known as ‘ICE’, is an open-source material carbon factor database. It contains UK-specific data as well as European and global averages, based on EPDs, some of which is referenced in Table 2.3. Similar databases from other countries are listed in Appendix A.

For offsite manufacture, A1–A3 includes all processes, transport and manufacture prior to delivery on site.

2.2.2.1 Unknown material or product specifications

Base your choice of A1–A3 carbon factors on default material specifications for the project’s country or region; unless you wish to commit to driving a particular material specification through the design process, and/or until you know more about where/how materials will be sourced.

Default values for commonly used structural materials (based on open-source data available at the time of publication) can be obtained from Table 2.3. For all data points in Table 2.3 it is indicated whether they are recommended for a UK project or elsewhere (defined as ‘Global’). Note that material ECFs are likely to change over time as production processes are made more efficient and the electricity grid decarbonises. If you cannot find materials that will be used on your project in Table 2.3, the ICE database or Section 2.2.2.2 of this guidance contains a list of EPD sources to look through.

- ⇒ The energy supply mix in different geographical areas can impact the carbon emissions associated with production of a product. Until you have confidence in the product to be used in construction, it is sensible to use regional, national or international average data points.
- ⇒ Table 2.3 is not exhaustive and is intended only to be used as your starting point. You should look for EPDs that best suit your projects and use those in your calculations. Note also that the table does not cover reclaimed materials — where A1–A3 carbon factors may be close to zero — highlighting again the need for reuse to be a key part of your design.

[†] Modules A1–A3 are normally aggregated and reported as a single carbon factor. In some circumstances, the modules may be reported individually; check each Environmental Product Declaration (EPD) that you use, to confirm this.

Table 2.3: Suggested embodied carbon factors ($ECF_{A1-A3,i}$) for common construction materials

Material	Type	Specification/details	Recommended default value	Typical lower bound	Typical upper bound	References		
						Default	Lower bound	Upper bound
Concrete	<i>In situ</i> concrete (unreinforced) ^a	UK C16/20	0.087 25% GGBS ^b	0.050 (70% GGBS)	0.113 (0% SCM ^b)	Ref. 19	Ref. 19	Ref. 19
		UK C20/25	0.093 25% GGBS ^b	0.053 (70% GGBS)	0.112 (0% SCM ^b)	Ref. 19	Ref. 19	Ref. 19
		UK C25/30	0.100 25% GGBS ^b	0.056 (70% GGBS)	0.119 (0% SCM ^b)	Ref. 19	Ref. 19	Ref. 19
		UK C32/40	0.120 25% GGBS ^b	0.063 (70% GGBS)	0.149 (0% SCM ^b)	Ref. 19	Ref. 19	Ref. 19
		UK C40/50	0.138 25% GGBS ^b	0.072 (70% GGBS)	0.159 (0% SCM ^b)	Ref. 19	Ref. 19	Ref. 19
		Global Average (excludes China) C32/40 ^c	0.175^d (mean)	0.139 ^d (20th percentile)	0.210 ^d (80th percentile)	Ref. 20	Ref. 20	Ref. 20
	Mortar/screed	1:4 cement:sand mix ^e with average UK cement mix ^f	0.149	–	–	Ref. 19	–	–
	Precast concrete ^a	UK C40/50, unreinforced ^g	0.178 (Average UK cement mix)	0.090 (70% GGBS)	0.191 (0% SCM)	Ref. 19	Ref. 19	Ref. 19
UK 150mm reinforced hollow core slabs: British Precast Flooring Federation average		50.2 kgCO_{2e}/m²	–	–	Ref. 21	–	–	
Steel	Reinforcement bars	UK CARES sector average (EAF production)	0.760	–	–	Ref. 22	–	–
		Global	1.960	0.395 (EAF production)	3.970 (BOF production)	Ref. 23	Ref. 24	Ref. 25
	PT strand	Assume the same as reinforcement bars	–	–	–	–	–	
	Structural sections and plate	UK Rolled open sections	1.740 (consumption average)	0.567 (EAF production)	2.450 (BOF production)	Ref. 26	Ref. 27	Ref. 28
		Global Rolled open sections	1.580	–	–	Ref. 23	–	–

Table 2.3: *Continued*

Material	Type	Specification/details	Recommended default value	Typical lower bound	Typical upper bound	References		
						Default	Lower bound	Upper bound
Steel <i>(continued)</i>	Structural sections and plate <i>(continued)</i>	UK & Global Closed sections	2.500	–	–	Ref. 29	–	–
		UK & Global Plate	2.450	–	–	Ref. 23	–	–
	Galvanised profiled sheet	UK TATA ComFlor®	2.830 (average of three EPDs)	2.810 (ComFlor® 51+ 0.9mm)	2.850 (ComFlor® 60 1mm)	Refs. 30–32	Ref. 31	Ref. 32
		Global Hot dip galvanised steel	2.670			Ref. 23		
Blockwork	Precast concrete blocks	UK Lightweight AAC blocks for building envelope (600kg/m ³)	0.280	–	–	Ref. 19	–	–
		UK Dense blocks for other uses	0.093	–	–	Ref. 19	–	–
Brick	Single engineering brick	UK BDA generic brick	0.213	–	–	Ref. 19	–	–
	Brick wall	UK Single skin wall with mortar 1:4 CEM I cement:sand mix	38.0 kgCO₂e/m²	–	–	Ref. 19	–	–
		UK Double skin wall with mortar 1:4 CEM I cement:sand mix	81.9 kgCO₂e/m²	–	–	Ref. 19	–	–
Stone	Granite	Generic ^h	0.093	–	–	Ref. 33	–	–
	Limestone	Generic	0.090	–	–	Ref. 19 (V2)	–	–
	Sandstone	Generic	0.060	–	–	Ref. 19 (V2)	–	–
	Granular fill	UK Aggregates and sand from a mixture of land-won, marine, secondary and recycled, bulk, loose	0.008	–	–	Ref. 19	–	–
		Global Aggregates and sand from virgin land-won resources, bulk, loose	0.004	–	–	Ref. 19	–	–

Table 2.3: *Continued*

Material	Type	Specification/details	Recommended default value	Typical lower bound	Typical upper bound	References		
						Default	Lower bound	Upper bound
Timber ⁱ	Studwork/ framing/flooring	Global Softwood, 100% FSC/PEFC	0.263	–	–	Ref. 19	–	–
	Manufactured structural timber	UK and Europe CLT, 100% FSC/PEFC	0.250 (European production average, 465kg/m³)	0.11 (Stora Enso)	0.63 (Wood for Good)	Ref. 34	Ref. 35	Ref. 36
		Global CLT, 100% FSC/PEFC	0.437			Ref. 19		
		UK and Europe Glulam, 100% FSC/PEFC	0.280 (European production average, 470kg/m³)	0.1 (EPD Norge)	0.64 (Wood for Good)	Ref. 34	Ref. 37	Ref. 36
		Global Glulam, 100% FSC/PEFC	0.512			Ref. 19		
		Global LVL, 100% FSC/PEFC	0.390	–	–	Ref. 19	–	–
		Sheet	Global Formwork plywood, 100% FSC/PEFC	0.681	–	–	Ref. 19	–
		Global OSB, 100% FSC/PEFC	0.455	–	–	Ref. 19	–	–
Aluminium	Sheet	European consumption 31% recycled content	6.58	–	–	Ref. 19	–	–
		Worldwide consumption 31% recycled content	13.0	–	–	Ref. 19	–	–
	Extruded profiles	European consumption 31% recycled content	6.83	–	–	Ref. 19	–	–
		Worldwide consumption 31% recycled content	13.2	–	–	Ref. 19	–	–
Glass	General	Generic	1.440	–	–	Ref. 19	–	–
	Toughened	Generic	1.670	–	–	Ref. 19	–	–
Plasterboard	Partitioning/ ceilings	Min. 60% recycled content	0.390	–	–	Ref. 19	–	–

Table 2.3: *Continued*

Material	Type	Specification/details	Recommended default value	Typical lower bound	Typical upper bound	References		
						Default	Lower bound	Upper bound
Intumescent coatings	Paint coating ^j for steel	Amotherm Steel WB	2.399	–	–	Ref. 38		
	Paint coating ^j for concrete	Amotherm Concrete WB	2.366	–	–	Ref. 38		
Cementitious coatings	Cementitious spray	Isolatek International product average ^k	0.725	–	–	Refs. 39–42		

Notes:

- ^a The ICE database has a wide range of concrete mixes, including PFA (pulverised fuel ash) and GGBS (ground granulated blast furnace slag) cements. Refer to Section 2.2.2.3 for more information.
 - ^b Supplementary cementitious materials (SCMs) are often used to replace Portland Cement, such as GGBS (Section 2.2.2.3). 25% GGBS is the default assumption for UK concrete. In 2021 the average SCM in UK concretes was 25.8%⁴³ and GGBS is the predominant SCM used in the UK due to diminishing use of PFA resulting from the phasing out of coal fired power.
 - ^c Concretes considered cover a $\pm 10\%$ strength range. Data point valid on 1 March 2022. Data point will change as more data is added in line with the *Embodied Carbon in Construction Calculator (EC3)* tool^{20,44}.
 - ^d Figures taken from 9,754 EFDs, primarily from the USA, and consistently being updated. Figures correct at 24 March 2022. Recommended default value has a relative standard deviation of $\pm 24.5\%$.
 - ^e The ICE database has many more cement:sand ratios to choose from.
 - ^f Taken from average UK sector cement EPD: 86.1% clinker, 0.04% GGBS, 3.4% fly ash, 4.8% gypsum, 5.1% limestone, 0.56% MACs, by weight.
 - ^g Includes energy for precasting and 30 miles travel for constituent materials.
 - ^h Data from life cycle analysis report from 2010 on UK quarrying activities³³.
 - ⁱ Timber A1–A3 carbon factors presented do not include sequestered carbon. The ICE database also includes timber A1–A3 embodied carbon factors including sequestration.
 - ^j Vinyl versatate polymers in an aqueous dispersion.
 - ^k Average of four Isolatek International EPDs produced to ISO 21930⁴⁵.
- Data is current at time of publication. Check sources to ensure accuracy at time of your calculation.
Upper and lower bounds are presented where sufficient data is available to highlight range of ECF_{A13} for that product.

2.2.2.2 Known material or product specifications

The accuracy of your carbon assessment will be greatly improved through the use of product-specific carbon data. As your design progresses, so too should your carbon assessment certainty.

EPDs provide detailed environmental impact information for a material or product, including A1–A3 carbon factors. Use these when you can be more certain about which countries or manufacturers your materials/products will be sourced from. You can also use information from EPDs to help influence which products should be used to fulfil a desired performance specification. Ask manufacturers for their EPDs or search for them online.

⇒ Make sure you always ask the manufacturer for the EPDs of their products — creating demand for good environmental practices is a positive action.

Otherwise, you can obtain EPDs from these websites:

- Environdec: <https://www.environdec.com>
- Institut Bauen und Umwelt: <https://ibu-epd.com/en/published-epds/>
- EPD Ireland: <https://www.igbc.ie/epd-search/>
- BRE Green Book Live: <http://www.greenbooklive.com/>
- Carbon Leadership Forum: <http://www.carbonleadershipforum.org/resources/>
- ECO Platform: <https://www.eco-platform.org/list-of-all-eco-epd.html>
- Transparency Catalog: <https://www.transparencycatalog.com/>
- Climate Earth: <https://www.climateearth.com>

Appendix A provides a list of carbon factor databases from various parts of the world.

EPDs often include only Modules A1–A3, so take care if you are combining EPD data with other sources that may include additional modules (e.g. A–C), as you will need to fill in the gaps (or at least note the limitations of such quick calculations). If you wish to use A4 and A5 data from an EPD, always check that the assumptions within these calculations align with the project-specific circumstances and/or the advice contained within Section 2.3 of this guidance.

BS EN 15804⁶ now requires construction products and materials EPDs to declare Modules A1–A3, C1–C4 and D. This will increase the availability of data for Modules C and D and can be integrated into your whole life carbon calculations, provided you can consider all materials and products in the same manner.

EPDs are normally valid for five years, and their validity date will be displayed on the EPD. Make sure the data you are using is valid.

For more information, refer to the ASBP briefing papers on EPDs^{46,47} and *How to read an EPD: basics for the structural engineer*⁴⁸.

2.2.2.3 Concrete

The embodied carbon of concrete is most heavily influenced by the amount of Portland Cement (PC) contained within it.

To reduce the embodied carbon of concrete, PC can be partially (or completely[†]) substituted by other cementitious materials commonly known as ‘cement replacements’ or ‘supplementary cementing materials’ (SCMs), the most common of which are Ground Granulated Blast Furnace Slag (GGBS)^{††}, Pulverised Fuel Ash (PFA)^{†††} and limestone. It should be noted that the production of GGBS and PFA are tied to carbon intensive industries. There are limited amounts produced (global availability of GGBS and PFA equates to an approx. total of 16% of global PC production)⁴⁹ and efforts to decarbonise energy supplies and steel production should result in decreased supplies in the future. Lehne and Preston⁵⁰, Allwood *et al.*⁵¹ and the Low Carbon Concrete Group⁵² provide further insights into possible low carbon concrete technologies that may be available in the future.

[†] Products such as Cemfree and LoCem use 100% GGBS alongside an alkali-activated cementitious material (AACM).

^{††} Waste product from blast oxygen furnace (BOF) route of production of steel.

^{†††} Waste product from coal-fired power plants.

Using a lower concrete strength grade will also reduce the total cementitious content requirement and thus embodied carbon. However, this may or may not reduce the embodied carbon of a reinforced concrete section, depending on the embodied carbon associated with any resulting increased demand for steel reinforcement and/or concrete volume to meet performance requirements.

Purnell and Black⁵³ have shown that for a given compressive strength, embodied carbon values of concrete can vary by a factor of around three, through varying the amount of PC. A similar trend is seen in Figure 2.4, where EPD data from more than 1,500 specific concrete mixes is plotted. For more insights on the variation of concrete and concrete constituent embodied carbon factors, refer to Anderson and Moncaster⁵⁴. Note that it may be possible to achieve your desired concrete strength with considerably less carbon than you imagined.

Figure 2.4: Example of possible variation in embodied carbon for concrete mixes. The concrete strength class reported is the highest value in given ranges for those mixes

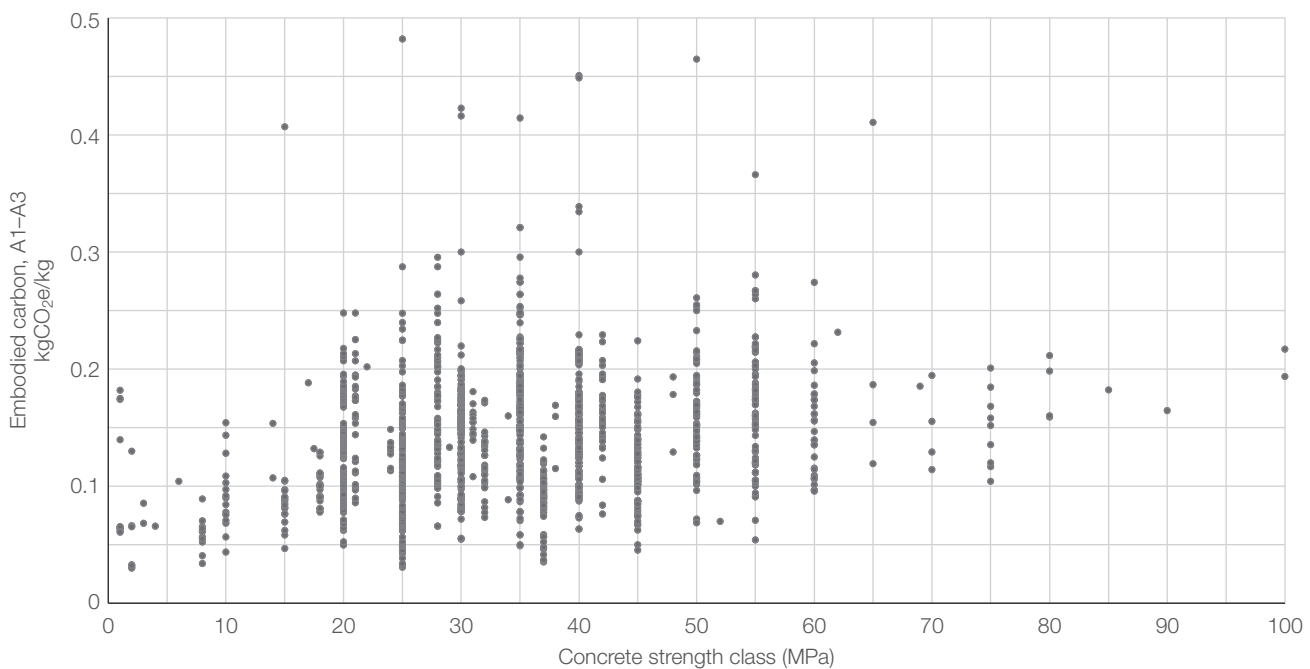

Cement type affects early age strength gain; generally, the higher the proportion of PC replacements the slower the strength gain. It is worth noting that for this reason, currently precast concretes typically have lower limits on the proportion of PC replacements (typically up to 25%), as concrete strength gain affects the production rate of precast products⁵⁵.

The amount of PC specified in a concrete mix is a function of application-specific requirements for strength, durability, workability and curing speed. Your concrete mix design should be optimised to achieve the functional requirements with minimum embodied carbon by carefully considering the mix of constituent materials. A concrete mix is typically designed by a concrete producer from a concrete specification. It is recommended that you engage the concrete producer when seeking low carbon concretes.

Refer to the MPA's *Specifying Sustainable Concrete*⁵⁶ for guidance. Note that material quantity reduction should always be your primary objective, followed by appropriate specification.

The ICE database provides the embodied carbon of a variety of concrete mixes of different strengths and degrees of PC replacement, some of which are included in Table 2.3. If you cannot find a carbon factor for a concrete that matches your concrete mix specification, you can calculate the embodied carbon of a specific mix using the freely available *Concrete Embodied Carbon Footprint Calculator*⁵⁷. Alternatively, for a more accurate estimate, ask your concrete supplier for a mix-specific embodied carbon calculation.

2.2.2.4 Steel

The Module A1–A3 carbon factor of steel varies depending on its recycled content and production method: basic oxygen furnace (BOF) or electric arc furnace (EAF). BOF is a fossil fuel-fired (mostly coal) production process that produces steel from high proportions of virgin iron ore compared to scrap metal (maximum 30% scrap⁵⁸, and typically 13% in the UK). EAF is a process powered by the electricity grid and can produce steel made with a very high recycled content (up to 100%⁵⁸, and typically 97% in the UK). Steel produced by EAF and with high recycled content generally has a much lower A1–A3 carbon factor than BOF-produced steel, and this may reduce further in future as electricity grids decarbonise.

Steel A1–A3 carbon factors also vary by steel product (e.g. hollow section, open section, plate) as the amount of processing they go through correlates to the amount of energy used in the manufacturing process, and some products are better suited to a specific production technique e.g. EAF or BOF. For example, steel plate and closed sections are typically only produced by BOF.

During the design stages, consumption-based averages for the geographic region relevant to your project will provide the most accurate representation of the A1–A3 emissions of the steel likely to be used. This will capture the mixture of imports and locally-produced steel your project is likely to consume.

If consumption-based data is not available, it is recommended to assume a production average ECF for the geographic region relevant to your project, as the majority of steel is likely come from local manufacturing sites. If a regional production average ECF is not available, the world average ECF from the ICE database can be used. For example, for a project in the UK using steel rolled open sections, use the average UK consumption A1–A3 ECF of 1.74kgCO₂e/kg²⁶. But for a project in Hong Kong using steel rolled open sections, the world average 1.58kgCO₂e/kg¹⁹ can be used in the absence of more locally-specific data.

Steel A1–A3 ECFs in Table 2.3 are based on the 100:0 recycling method, which effectively only takes the benefits from recycled scrap content in its production into account. Any benefits from recycling steel at end of life should be accounted for in Module D (Section 2.2.6), not in Modules A1–A3. The ICE database provides more information on different methods of accounting for recycled content and recycling rate.

2.2.2.5 Timber

Biogenic carbon vs fossil carbon, and emissions vs transfers

Carbon dioxide is removed from the atmosphere as trees grow — via photosynthesis, known as ‘sequestration’. The carbon element of this CO₂ is temporarily stored within timber until it is released at end of life in the form of a greenhouse gas (CO₂ or CH₄), for example by burning or decomposition of the timber. This stored carbon is known as ‘biogenic carbon’. Locking biogenic carbon into a timber structure is of climatic benefit for as long as the carbon is kept within that structure, though the storage itself does not negate the immediate effects of fossil carbon emissions (e.g. those emitted during the production of a timber beam).

Biogenic carbon is not considered in the same way as fossil carbon. While fossil carbon is typically **emitted** due to the production/construction of a timber structure, biogenic carbon is instead **transferred into** the structure during production/construction. At the structure’s end of life, the biogenic carbon is then either transferred out of the structure (e.g. sending the timber for reuse), emitted into the atmosphere (e.g. incineration for energy), or both (e.g. sent to landfill). This is illustrated in Figure 2.5.

For more detail on the end of life emissions and transfers in timber, refer to Section 2.2.5.2.3.

Figure 2.5: Sequestered biogenic carbon (transfers/emissions) and fossil carbon (emissions) for a typical timber structure

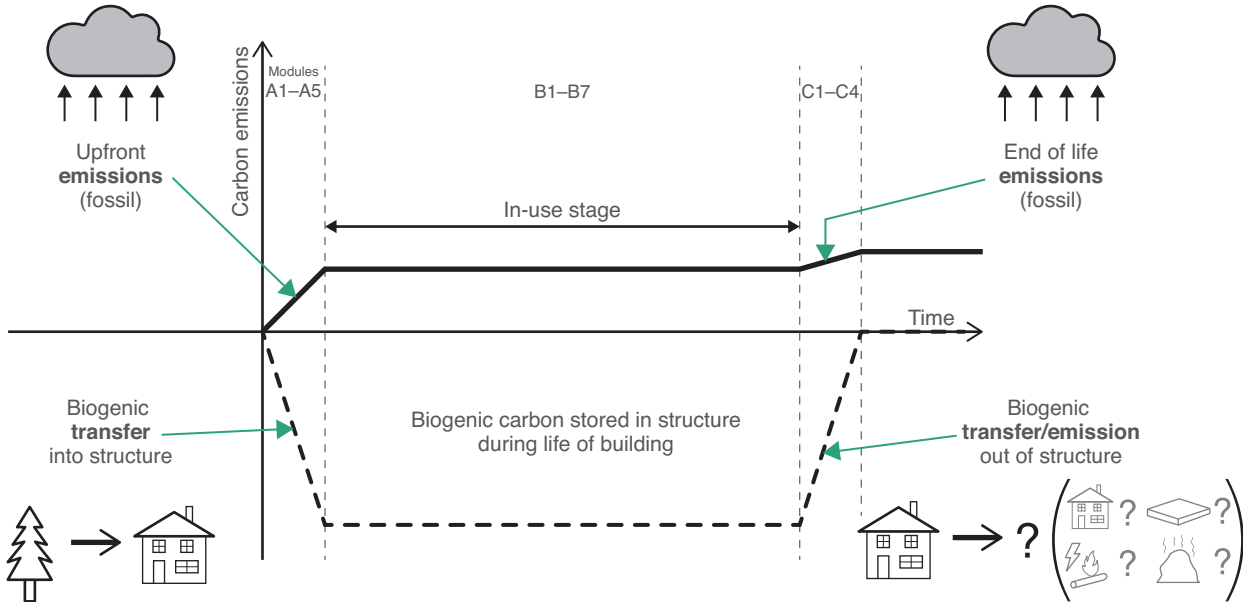

Calculating biogenic carbon

In the absence of product specific data, biogenic carbon sequestered can be assumed as $-1.64\text{kgCO}_2\text{e}$ per kg of timber[†].

This value is derived from Equation (2.1), which is adapted from BS EN 16449⁵⁹:

$$S_{CO_2} = \frac{44}{12} \times cf \times \frac{1}{1 + \frac{\omega}{100}} \tag{2.1}$$

Where:

- S_{CO_2} = carbon sequestered, per kilogram of product, from atmosphere (kgCO_2/kg)
- cf = carbon fraction of woody biomass (oven dry mass) (assume 0.50 in absence of product specific information)
- ω = moisture content (assume 12% in absence of product specific information)

It should be noted that EPDs for timber products are required to report biogenic carbon separately to fossil carbon for A1–A3 carbon factors, in accordance with BS EN 15804:2012 + A2:2019^{6,††}. If using an EPD written to the older BS EN 15804 + A1:2013⁶¹, then when reporting A1–A5 calculations the sequestered biogenic carbon calculated using Eqn. (2.1) should be extracted from the A1–A3 carbon factor in the EPD. This will yield the fossil carbon emissions due to production processes alone.

The ICE database provides two sets of A1–A3 carbon factors for timber products; one including sequestration and the other excluding sequestration (the latter is included in Table 2.3). End of life emissions associated with timber products (e.g. CO_2 release from incineration or CO_2 and CH_4 release during landfill) are reported in Stage C (Section 2.2.5.2 of this guidance).

Hart and Pomponi⁶² and Ramage *et al.*⁶³ provide useful starting points for readers who wish to delve further into carbon balances in forests and the use of timber in construction.

[†] This assumes default values given in the RICS guidance⁷ of carbon factor woody biomass = 50% and moisture content = 12%.
^{††} BS EN 15804:2012 + A2:2019 follows the guidance of BS EN 16485⁶⁰.

Reporting biogenic carbon

Uptake of biogenic carbon should only be reported if the timber originates from a sustainably managed forest with FSC or PEFC (or equivalent) certification, as this ensures replanting of any felled trees, meaning that the sequestration is of long-term climatic benefit (compared with leaving the trees unfelled).

Your assessment's life cycle stages scope dictates how biogenic carbon is reported in your results. In line with RICS guidance⁷, if your scope covers:

- Modules A1–A5: **do not include biogenic carbon** within the A1–A5 total value but report it separately alongside the A1–A5 total (Fig. 2.8, Section 2.3.5)
- Stages A–C: **include biogenic carbon** within the total A–C value reported (Fig. 2.8, Section 2.3.5). You may choose to also report the biogenic carbon separately alongside the A–C total, to help communicate the benefit of locking away carbon during the building's life (Section 2.2.5.2.3)

The rationale behind not including sequestered biogenic carbon when reporting the total A1–A5 value, but reporting it separately alongside, is:

- Including biogenic carbon in the A1–A5 total would typically result in a negative value for A1–A5 embodied carbon (i.e. showing a net extraction of carbon emissions from the atmosphere). This could allow engineers to show that less efficient use of timber results in a lower value (i.e. a greater negative value) of embodied carbon. This must be avoided to prevent unnecessary use of resources
- We should not ignore the fact that sequestration of biogenic carbon happens, and is of climatic benefit — therefore we should report it

Where schemes have similar A1–A5 fossil emissions, but one has significant biogenic carbon sequestration, use your judgement to decide which scheme has most climatic benefit on a case-by-case basis. Going beyond minimum scope and undertaking a full life cycle assessment is advised, to best capture the full climate impacts of your designs.

2.2.2.6 Temporary works

In a building level assessment, although A1–A3 and A4 carbon factors for temporary works materials are used, their impact should only be reported within Module A5 (Section 2.2.4).

Now you have a list of materials, their quantities and a corresponding list of ECFs for Modules A1–A3.

2.2.3 Module A4 carbon factors

Module A4 is likely to account for a modest percentage of structural embodied carbon over the life cycle of a building project. For heavy civil works, Module A4 emissions may be more significant.

Module A4 is concerned with transport of materials or products from the factory gate to the construction site, and the transport of construction equipment (cranes, scaffolding, etc.) to and from the site.

- ⇒ Remember that some journeys comprise multiple legs over different transport modes. You need to include the whole journey in your calculations.
- ⇒ Reuse of components, materials or products that are locally sourced and transported over short distances will help to reduce both Module A4 and overall project emissions.

The carbon factors for transportation of each material to site are calculated by multiplying the transportation distances by the respective transportation modes' emissions factors (Equation (2.2)):

$$ECF_{A4,i} = \sum_{mode} (TD_{mode} \times TEF_{mode}) \quad (2.2)$$

Where:

- $ECF_{A4,i}$ = embodied carbon factor for transport to site for i^{th} material
- TD_{mode} = transport distance for each transport mode considered
- TEF_{mode} = transport emission factor for each transport mode considered

True transportation embodied carbon factors for each material will not be known until the project is completed and the material transportation modes and distances have been recorded. In the absence of precise information, the information that follows can be used to estimate $ECF_{A4,i}$.

Transport emissions factors (TEFs) suitable for use by UK-based organisations of all sizes, and international organisations reporting on UK operations are provided in Table 2.4. Additional TEF values for other transport modes are available from *Greenhouse gas reporting: conversion factors 2021*⁶⁴. Emissions factors for other regions can be found online and should be investigated for projects operating outside the UK – e.g. rail transport emissions vary depending on the electric/diesel mix in each country.

Table 2.4: Example transport emissions factors for the UK

Mode	TEF_{mode} (gCO ₂ e/kg/km)	Source
Road transport emissions, average laden	0.10749	Ref. 64 ^a
Road transport emissions, fully laden	0.07375	Ref. 64 ^b
Sea transport emissions	0.01614	Ref. 64 ^c
Freight flight emissions	0.53867	Ref. 64 ^d
Rail transport emission	0.02782	Ref. 64 ^e

Notes:

- ^a For HGVs (all diesel), average laden.
- ^b For HGVs (all diesel), fully laden.
- ^c For cargo ship/container ship, average.
- ^d International, to/from non-UK (direct effects from CO₂, CH₄ and N₂O emissions only).
- ^e Freight train.

⇒ The units of TEF (gCO₂e/kg/km) are from kgCO₂e per tonne.km data points⁶⁴. This metric is rather crude and may be best suited to early design stages. The dataset also provides kgCO₂ per vehicle km data, which provides a more refined calculation if you know the transport requirements for specific materials and products.

Transport distances should be estimated based on project specific scenarios.

In the absence of such data, transport distances for projects in the UK can be estimated using the default distances contained in the RICS guidance⁷ and those given in Table 2.5 along with the resulting ECF_{A4} value.

The values in Tables 2.4 and 2.5 should be used with care and updated with improved data as your project progresses. Take care to ensure that transport distance comparisons are fair and reasonable for each product and material.

⇒ Ask your manufacturers for predicted logistics for the supply chain, to get a better idea of Module A4 emissions.

Table 2.5: Default ECF values for Module A4 for the UK ($TD_{mode} \times TEF_{mode}$)

A4 transport scenario	km by road	km by sea	$ECF_{A4,i}$ (kgCO ₂ e/kg)
Locally manufactured	50	–	0.005 50km × 0.10749gCO ₂ e/kg/km/1,000
Nationally manufactured	300	–	0.032
European manufactured	1,500	–	0.161
Globally manufactured	200	10,000	0.183

2.2.4 Module A5 carbon factors

Module A5 is likely to account for a small, but not insignificant, percentage of structural embodied carbon over the life cycle of a building project[†].

In this guide, Module A5 emissions are broken down into two subsets. Emissions associated with the volume of each material that is wasted on site are identified as **A5w** emissions (Equation (2.3)). Emissions due to general construction activities e.g. energy use from machinery and temporary site offices, are identified separately as **A5a** emissions (Equation (2.5)).

2.2.4.1 Material wastage on site (A5w)

The carbon factor for material wastage on site is calculated by multiplying a waste factor by the sum of the carbon factors associated with the production (A1–A3), transportation to site for construction (A4), transportation away from site for waste processing (C2), and waste processing or disposal (C3–C4) for a product:

$$ECF_{A5w,i} = WF_i \times (ECF_{A13,i} + ECF_{A4,i} + ECF_{C2,i} + ECF_{C34,i}) \quad (2.3)$$

Where:

- $ECF_{A5w,i}$ = construction waste embodied carbon factor for i^{th} material
- WF_i = waste factor for i^{th} material given by Equation (2.4)
- $ECF_{A13,i}$ = embodied carbon factor for A1–A3 for i^{th} material
- $ECF_{A4,i}$ = embodied carbon factor for transport to site for i^{th} material
- $ECF_{C2,i}$ = transportation away from site carbon factor (Section 2.2.5.2.2) calculated in the same way as $ECF_{A4,i}$ but transport distance is assumed to be 50km by road if taken for reuse or recycling elsewhere (default assumption from RICS guidance⁷), i.e. 0.005kgCO₂e/kg, or average distance between two closest landfill sites for landfill or incineration
- $ECF_{C34,i}$ = waste processing and disposal embodied carbon factor (Section 2.2.5.2.3)

$ECF_{A13,i}$ embodied carbon factor includes carbon sequestration for any timber products wasted during construction, as Module A5 also accounts for the end of life of timber products wasted in $ECF_{C34,i}$. As explained in Section 2.2.2.5, sequestration should be included where end of life emissions are accounted for.

The waste factor WF_i is calculated by converting the waste rate WR_i (a percentage of the quantity of materials brought to the site that are wasted) to the quantity of materials wasted on site as a percentage of the material quantities used in the final asset (Eqn. 2.4):

$$WF_i = \left(\frac{1}{1-WR_i} - 1 \right) \quad (2.4)$$

Where:

- WR_i = waste rate (quantity of materials brought to site that ends up as waste during installation and/or construction process) of i^{th} material, which can be estimated using the WRAP's *Net Waste Tool* data⁶⁵ (Table 2.6 of this guidance)

[†] For heavy civil works, A5 may be more significant.

Table 2.6: Recommended waste rate data, primarily from the WRAP's *Net Waste Tool*^{65,a}

Material/product	WR (waste rate)	WRAP <i>Net Waste Tool</i> reference	WF (waste factor)
Concrete <i>in situ</i>	5%	Table 2, Concrete <i>in situ</i>	0.053
Mortar	5%	Table 2, Gypsum products	0.053
Screed	5%	Table 2, Screed	0.053
Concrete precast (beams and frames)	1%	Table 2, Concrete precast (large precast elements)	0.010
Steel reinforcement	5%	Appendix 1, Frame: <i>In situ</i> concrete frame generic Table 2, Ferrous metals	0.053
Steel frame (beams, columns, braces)	1%	Appendix 1, Frame: Steel frame generic	0.010
Concrete blocks	20%	Table 2, Bricks and blocks	0.250
Brick	20%	Table 2, Bricks and blocks	0.250
Stone	10%	Table 2, Stone	0.111
Timber frames (beams, columns, braces)	1%	Appendix 1, Frame: timber frame	0.010
Timber floors (joists, board)	10%	Appendix 1, Floor: wooden floor	0.111
Timber formwork	10%	Table 2, Processed timber	0.111
Aluminium frames	1%	Appendix 1, Conservatories: aluminium frame	0.010
Glass	5%	Table 2, Glass	0.053
Plasterboard (for boarding)	22.5%	Table 2, Plasterboard Table 3, Boarding	0.290
Sprayed cementitious fire protection to steel	10%	Table 3, Cementitious sprays	0.111

Note:

^a The WRAP *Net Waste Tool* presents baseline and good practice waste rates for each material/system. Only the baseline waste rates are presented here.

During design, it will be necessary to estimate the waste rate based on industry average data. The most recently published industry data, from the WRAP's *Net Waste Tool*, is summarised for structural materials and systems in Table 2.6. These data are a guide only, and you are encouraged to find updated information on waste rates from contractors you work with or in specific EPDs for products you are using.

- ⇒ It is important to make it a requirement of the contractor to collect the waste rate data for the different products used on site. This information can then be used to produce an accurate as-built Module A5 embodied carbon calculation and inform industry average data on waste rates.
- ⇒ During construction, waste rates should be minimised where possible, and efforts must be made to find reuse or recycling streams for any unused materials and components. This is key to enabling the construction industry to transition to a circular economy.

For components that are prefabricated off site, the material waste rate on site is likely to be lower than if they were constructed on site — with a maximum waste factor *WF_i* of 0.010⁶⁶. This is reflected in the UK construction site

waste rate data presented in Table 2.6. For prefabricated products, wastage in the factory should be accounted for in Module A3.

For temporary works materials, use a waste factor of $[1.00 + (\text{material/product waste factor})]$ (also refer to Section 2.2.4.1.1).

2.2.4.1.1 Temporary works materials

Temporary works used on site during the Construction Process stage are accounted for in Module A5.

Examples of temporary works are:

- Timber formwork for *in situ* RC frames
- Steel frames used to stabilise existing structures during construction

The way you calculate the embodied carbon of temporary works materials depends on the level of certainty you have regarding their previous and future uses.

The default position, for a building level assessment that includes Modules A1–A5, should be that all temporary works materials arriving on site are new and will be wasted (i.e. cannot be used on a future project) giving A5w emissions for temporary works materials using Eqn. (2.3) with a waste factor of $[1.00 + (\text{material/product waste factor})]$ in accordance with Table 2.6.

Where it is known with some certainty that temporary works materials have been used on past projects and/or will be reused on subsequent projects, you can account for this by reducing (pro-rata) the $ECF_{A13,i}$ and $ECF_{C34,i}$ factors in Eqn. (2.3). Be aware that if the materials are subsequently not reused (and are instead wasted) then your calculation will be an underestimate.

It should be noted that, for new builds, unless significant temporary works are required, their contribution to the total structural embodied carbon is likely to be relatively small.

2.2.4.1.2 Excavation

The carbon impacts of excavation on site should be accounted for in Module A5. The removal of excavated material from the site is accounted for in A5w (Section 2.2.4.1), and the emissions from on-site machinery used to excavate the material are accounted for in A5a (Section 2.2.4.2).

In most cases, $ECF_{A5w,i}$ is equal to $ECF_{C2,i}$ – the emissions released in transporting the excavated material away from site (Section 2.2.5.2.2). In some cases, waste processing may be required for excavated material, in which case $ECF_{C34,i}$ should be taken into account, but there are no production or transportation to site emissions. In other words, in Eqn. (2.3) for excavation material, $WF_i = 1$, $ECF_{A13,i} = 0$, $ECF_{A4,i} = 0$, and often $ECF_{C34,i} = 0$.

Until we have better data on site activities emissions, we can assume that on-site excavation machinery emissions are accounted for in Eqn. (2.5). See Section 2.2.4.2.

2.2.4.2 Site activities (A5a)

Site activity emissions can be estimated from on-site electricity consumption and fuel use, and should be monitored during construction to contribute to an accurate as-built embodied carbon calculation at practical completion (Section 2.4.2). Any site activity emissions data collected can also be used to inform estimates of A5a emissions in future projects.

In the absence of project specific data, prior to construction starting, A5a emissions can be estimated based on industry studies or previous project data. In the UK, the RICS guidance⁷ provides a rate of 1,400kgCO₂e per £100,000 construction cost for the whole building to be used in the absence of site specific data.

For superstructure and substructure only, a factor of this figure can be assumed based on a predicted proportion of site activity emissions (based on construction effort, required machinery and time) due to construction of these

elements. As a preliminary estimate, this may be in the order of 50% — resulting in a rate of 700kgCO₂e per £100,000 for A5a emissions of substructure and superstructure only.

If your project predominantly uses off-site manufacturing methods, a reduced construction emissions factor of 500kgCO₂e per £100,000 for total substructure and superstructure may be assumed, to reflect the reduced construction activities required on site⁶⁶.

In the absence of more accurate data, using the metric in the RICS guidance⁷, A5a emissions are calculated by multiplying the construction cost by a construction activities emissions factor (Eqn. (2.5)):

$$EC_{A5a} = CAEF \times \frac{PC}{100,000} \quad (2.5)$$

Where:

- EC_{A5a} = embodied carbon from construction site activities (A5a)
 $CAEF$ = construction activities emission factor of 700kgCO₂e/£100,000 for superstructure and substructure only, or 1,400kgCO₂e/£100,000 for whole building
 PC = project cost

- ⇒ Ask your contractor to record on-site emissions and feed this data into the as-built carbon assessment. Note that there are available credits for doing this in environmental certification schemes, e.g. BREEAM.
- ⇒ Encourage your contractor to minimise diesel fuel use and supply electricity from renewable sources to minimise A5a emissions.

Now you have a list of materials, their quantities and a corresponding list of ECFs for Modules A1–A5.

2.2.5 Stages B and C carbon factors

The information in this section primarily follows recommendations provided in the RICS guidance⁷.

2.2.5.1 Stage B carbon factors

Modules B1–B5 together are likely to account for a very small, and sometimes negligible, percentage of structural embodied carbon over the life cycle.

For infrastructure projects with a reference design life of 120 years, individual components may have to be replaced many times, which can increase the capital carbon impact through greater Stage B emissions. Encouraging more durable upfront design options can make a difference.

Module B4 (replacement) is typically the focus of the Use Stage (Stage B) in embodied carbon assessments.

Guidance on Modules B1–B3 and B5 are included here for information. You should be aware that:

- Module B1 (use) is generally insignificant for structural materials
- Very little data exists for Modules B2 (maintenance) and B3 (repair)
- Module B5 (refurbishment) refers to planned changes in use, defined at the start of the project
- Modules B6–B8 (operational carbon) and B9 (user carbon) are beyond the scope of this guide

Stage B carbon factors depend on the lifespan of the built asset which, in carbon assessments, is represented by the reference study period (RSP). The default RSP to be used for building projects is 60 years, and 120 years for infrastructure projects⁷.

2.2.5.1.1 B4 Replacement

Module B4 relates to the embodied carbon associated with replacing building elements during the life cycle of the asset (the RSP) e.g. replacement of the facade during the lifetime of the building. It is part of the minimum scope of embodied carbon calculation where facades are assessed. The inputs required are:

- Estimated component lifespan for i^{th} material, CL_i .
For substructure and superstructure elements, the default should be equal to the asset reference study period, i.e. they are not replaced during the building life cycle.
For paints (e.g. intumescent) and other building elements, e.g. facades and MEP services, the lifespan is likely to be shorter than the RSP. To obtain the component lifespan, the designer can ask the product manufacturer or use industry experience or evidence. Ideally, the designer will advocate that a commitment is made to maximise component lifespans through a robust maintenance regime.

In the absence of manufacturer information or occupier commitments, default values from the RICS guidance⁷ should be used for component lifespans

- Asset RSP.

The suggested default RSP is 60 years for buildings, and 120 years for infrastructure⁷.

The carbon factor for Module B4 is the number of times a component is replaced in the built asset's life cycle multiplied by the sum of the carbon factors for life cycle modules A1–4, A5w and C2–C4 (Equation (2.6)):

$$ECF_{B4,i} = \left\lceil \frac{RSP}{CL_i} - 1 \right\rceil \times (ECF_{A13,i} + ECF_{A4,i} + ECF_{A5w,i} + ECF_{C2,i} + ECF_{C34,i}) \quad (2.6)$$

Where:

$ECF_{B4,i}$ = replacement emissions for i^{th} material

RSP = asset reference study period

CL_i = estimated component lifespan for i^{th} material

$\left\lceil \frac{RSP}{CL_i} - 1 \right\rceil$ means round up the value of $(RSP/CL_i) - 1$ to the next integer

$ECF_{A13,i}$ = A1–A3 embodied carbon factor for the i^{th} material (Section 2.2.2). In this case it includes carbon sequestration for any timber products replaced during the RSP, because Module B4 also accounts for the end of life of timber products replaced in $ECF_{C34,i}$. As explained in Section 2.2.2.5, sequestration should be included where end of life emissions are accounted for

$ECF_{A4,i}$ = embodied carbon factor for transport to site for i^{th} material

$ECF_{A5w,i}$ = construction waste embodied carbon factor for i^{th} material (Section 2.2.4.1)

$ECF_{C2,i}$ = transportation away from site embodied carbon factor for the i^{th} material (Section 2.2.5.2.2)

$ECF_{C34,i}$ = waste processing and disposal embodied carbon factor (Section 2.2.5.2.3)

It should be noted that at the time of calculation, both the asset reference study period and component lifespans are assumptions, as it is difficult to accurately predict future actions. These assumptions should be clearly stated and justified when reporting embodied carbon.

2.2.5.1.2 Further information on B modules

B1 Use

Regarding structure, Module B1 (use) emissions are generally insignificant for structural materials.

Concrete surfaces exposed to the atmosphere absorb CO_2 during a built asset's life cycle through the carbonation process. This is estimated to account for up to 2.5% reabsorption of the CO_2e emitted in the Product stage (Modules A1–A3)⁶⁵.

Most concrete manufacturers include an allowance for this in their EPDs. If using manufacturers' EPDs to quantify carbonation, check the assumptions contained within the EPD to ensure they match the conditions of your project, e.g. check the study period and atmospheric exposure assumed.

B2 and B3 Maintenance and repair

Very little data is available to inform carbon factors for maintenance (B2) and repair (B3) for structural materials and it is assumed that emissions from B2 and B3 activities are negligible for structure.

B5 Refurbishment

Module B5, different to B4 (replacement), is defined as *planned alteration or improvement works to enable the asset to cater for a desired future function identified and quantified at the outset*⁷. This generally corresponds to a change of use and significant works to several parts of the building.

2.2.5.2 Stage C carbon factors

Modules C1–C4 are likely to account for a small percentage of structural embodied carbon over the life cycle, unless timber products are used.

Note that the certainty of carbon factor data for the end of life (EoL) of a built asset is very low, as it relates to activities in the distant future. However, project EoL scenarios should be developed to inform whether design measures can be implemented to ensure the lowest emissions scenario is enabled at the EoL. This section provides carbon factor estimates to use to calculate Stage C emissions based on existing industry guidance (primarily the RICS guidance⁷). If other assumptions are made in your calculations, they should be clearly stated.

2.2.5.2.1 C1 Demolition and deconstruction

In the absence of information from a contractor, an average rate from the RICS guidance⁷ can be assumed (Equation (2.7)):

$$EC_{C1} = 3.4\text{kgCO}_2\text{e/m}^2 \text{ GIA} \tag{2.7}$$

Where:

- EC_{C1} = embodied carbon due to demolition and deconstruction
- GIA = gross internal area (i.e. the area of a building measured to the internal face of the perimeter walls at each floor level⁶⁷)

2.2.5.2.2 C2 Transportation

Transportation of materials away from site at EoL is calculated in exactly the same way as A4 transportation emissions, but the waste processing or disposal facilities are likely to be local to the site, so the transportation distances are likely to be shorter. Default assumptions from the RICS guidance⁷ can be used (Table 2.7).

2.2.5.2.3 C3 and C4 Waste processing and disposal

Carbon factors for waste processing for reuse, recovery or recycling (C3) and disposal (C4) are often grouped together in embodied carbon assessments as the two scenarios are mutually exclusive.

Table 2.7: Default values for Module C2 ($TD_{mode} \times TEF_{mode}$)

EoL scenario	km by road	$ECF_{C2,i}$ (kgCO ₂ e/kg)
Reuse/recycling on site	0	0.00
Reuse/recycling elsewhere	50	0.005 50 × 0.10749 gCO ₂ e/kg/km/1,000
Landfill/incineration	Average between two closest landfill sites	0.005 (based on 50km by road)

⇒ Suitable project-specific scenarios for Modules C3 and C4 should be developed based on the project team's intentions to minimise embodied carbon, or justified based on precedent and current EoL practices⁷.

Data for Modules C3 and C4 embodied carbon factors $ECF_{C34,i}$ should be taken from EPDs if available and relevant, and if the product specification is known. As mentioned in Section 2.2.2.2, it should be noted that EPDs are now required to report Modules C3 and C4 ECFs. Where EPD data for Modules C3 and C4 is unavailable, the default carbon factor in Equation (2.8) can be used:

$$ECF_{C34,i} = 0.013\text{kgCO}_2\text{e/kg waste} \quad (2.8)$$

Where:

$ECF_{C34,i}$ = waste processing and disposal embodied carbon factor

Timber EoL emissions

The reporting of EoL emissions (Modules C3 and C4) is complicated due to the presence of biogenic carbon – with BS EN 16485⁶⁰ differentiating between a **transfer** of biogenic carbon into another product, project or to nature, and an **emission** of biogenic carbon into the atmosphere (Section 2.2.2.5 of this guide). Whether those transfers/emissions are reported under Module C3 (waste processing) or C4 (disposal) also varies e.g.:

- The EoL reuse of a wood product (from the structure being studied, into a possible future structure) is reported as a transfer of carbon (into the new structure) in Module C3
- Recycling a wood product (e.g. recycling solid timber joists into particleboard) is reported as a C3 transfer of carbon in the same way as reuse is. However, there will be additional fossil carbon emissions due to the EoL processing, which is necessary before the new recycled product can be created
- Landfilling a wood product includes C4 emissions (due to the emission of landfill gases for the first 100 years) and C4 transfers (to nature, for any carbon remaining beyond those 100 years)
- Incinerating a wood product counts as an emission into the atmosphere, but whether this is C3 or C4 depends on the efficiency of the incinerator⁶

Due to this complexity, and the lack of certainty over EoL use of timber, emissions and transfers across Modules C3 and C4 should be reported together as a single C3–C4 number.

Locking sequestered biogenic carbon into a timber structure is of greater climatic benefit the longer the carbon is kept within that structure – and so designing structures and components to be reused will keep the biogenic carbon locked away for as long as possible. This is achieved by designing for life extension, adaptation, deconstruction and reuse. However, the approach of reporting C3–C4 transfers/emissions together means that the emissions benefit of these design strategies is not reflected in the whole life carbon reported for the project.

To communicate the benefits of these design strategies, ensure that you always report the total amount of carbon sequestered as part of any carbon assessment undertaken, and emphasise that these design strategies can keep biogenic carbon locked away for as long as possible.

At the same time, be sure to note that this locking away of carbon does not negate the parallel effects of the fossil-based greenhouse gases that are emitted due to production, transport and construction processes. You should also be mindful of how little control you have today over what happens to the timber after the building's EoL.

All materials should be detailed to enable life-extension, deconstruction and reuse where possible, to minimise future Module A1–A5 emissions on other projects. Detailing timber to enable deconstruction and reuse also reduces biogenic emissions into the atmosphere at the end of the project's life.

Table 2.8 shows the variation that can be seen in ECF_{C34} for timber products based on the different EoL routes. UK-based projects may use the 2017 Wood for Good EPD EoL scenario combination (right hand column of

Table 2.8)⁶⁸. This yields a similar C3–C4 ECF compared to an EoL scenario based on TRADA data⁶⁹. Further guidance, data collection and data transparency are required, to provide more robust timber product ECF_{C34} values for use in different geographical regions.

Note that, as described in Section 2.2.2.5, if EoL (Modules C3 and C4) biogenic emissions/transfers associated with timber products are included in the embodied carbon assessment, so too should carbon sequestration be included in Modules A1–A3, provided that the timber originates from a sustainably managed forest with FSC or PEFC (or equivalent) certification.

Table 2.8: UK Timber EoL scenarios and associated approx. C3 and C4 carbon factors

EoL scenario	Description	UK default C3 and C4 emissions factors	UK EoL scenario (average of all timber products) ⁶⁸
Reuse	For future use in other assets. Biogenic carbon transferred to next use.	1.64kgCO ₂ e/kg (equal to default sequestered carbon) ^b	0%
Recycling	For use in animal bedding/surfacing, panel board products. Biogenic carbon transferred to next use. Fossil carbon due to pre-manufacture processing.	1.67kgCO ₂ e/kg ^{70,b}	55%
Incineration for energy recovery	Biomass fuel (domestic or export). Biogenic carbon emitted to atmosphere.	1.64kgCO ₂ e/kg (equal to default sequestered carbon) ^{7,b}	44%
Landfill (no gas recovery) ^a	A proportion of biogenic carbon re-released as CO ₂ and CH ₄ , with the remainder transferred to nature.	2.15kgCO ₂ e/kg ⁷	1%
		Total ECF_{C34} 1.66kgCO ₂ e/kg	
Notes:			
^a Modern landfill sites often employ techniques to capture gases from decomposition of organic matter.			
^b Factors shown for reuse, recycling and energy recovery are based on default biogenic carbon emissions or transfers of 1.64kgCO ₂ e/kg (Section 2.2.2.5) plus other emissions associated with processing required in each scenario.			

Concrete EoL carbonation

Similar to Module B1 (use), concrete can absorb CO₂ through the carbonation process at the EoL.

After demolition of the asset and before the resulting crushed concrete (hardcore) is used elsewhere, carbonation rates can increase as the concrete surface area to volume ratio is increased. The Concrete Centre estimates that during this time up to a further 5% of the concrete A1–A3 emissions can be reabsorbed, based on the assumption that, on average, concrete crushed on site at EoL sits on site for 26 weeks before being removed⁷¹. In some locations the time that crushed concrete may spend on site is much shorter, resulting in a much smaller percentage of A1–A3 emissions reabsorbed.

2.2.6 Module D carbon factors

Module D represents the estimated benefits or burdens of materials and components beyond the EoL of the built asset under consideration. It provides a good metric of circularity[†], an attribute that is key to enabling the decarbonisation of the construction industry.

Calculating Module D emissions requires quantifying the difference in emissions between utilising recovered materials (through reuse, recycling or incineration) and producing a functionally equivalent product with standard practices and market averages. Equation (2.9) represents this difference in emissions for reuse and recycling:

[†] Circularity is a term commonly used to describe the ability of something to contribute a low carbon circular economy^{72,73}. Describing the circular economy is not within the scope of this guidance.

$$ECF_{D,i} = ECF_{A13,secondary\ product} - ECF_{A13,substituted\ product} \quad (2.9)$$

Where:

- $ECF_{D,i}$ = carbon factor of the benefits (emissions reductions) or burdens (increase in emissions) of a product beyond the EoL of your project for a particular EoL scenario
- $ECF_{A13,secondary\ product}$ = A1–A3 embodied carbon factor for a product that benefits from the reuse or recycling of the product used on your project
- $ECF_{A13,substituted\ product}$ = market average A1–A3 embodied carbon factor for the type of product in question

These impacts are beneficial when the future use of the material after EoL results in practices that are less carbon intensive than the business as usual use case, e.g. steelmaking from 100% scrap steel (secondary product) has lower A1–A3 carbon emissions than steelmaking from 80% virgin iron and 20% scrap steel (substituted product). Therefore, Module D impacts are dictated by the EoL scenarios for each material or component; either reuse, recycling (e.g. of steel), incineration (e.g. of timber products) or landfill.

EoL scenarios are uncertain for most materials as they relate to actions taken at some point in the distant future, therefore Module D impacts can also be uncertain. For example, the Module D benefit for incinerating timber to produce energy will depend on how much progress has been made in decarbonising the electricity grid by the time the incineration takes place. For materials that retain value at EoL, e.g. those materials that can easily be recycled or reused, the likely range of EoL scenarios may have some certainty, but the carbon impacts associated with each scenario may still vary significantly.

- ⇒ Engineers should consider the most plausible combination of EoL scenarios when calculating Module D, and clearly state the basis of their assumptions.
- ⇒ Make sure that the EoL scenarios for timber products assumed for Module D match those assumed for Modules C3 and C4 for each scenario assessed.

Where available, Module D impacts can be taken from EPDs for specific materials or products, and the associated assumptions of EoL scenarios should be checked against project specific information and scenarios. Table 2.9 shows ECFs for Module D taken from the EPDs in Table 2.3 (where provided).

- ⇒ Where the relevant data is unavailable, and for further guidance on Module D, refer to the RICS guidance⁷ and consider Module D qualitatively.

Module D impacts should always at least be considered qualitatively. Even if the scope of the assessment is Modules A1–A5, you should consider whether your design would be reusable or recyclable beyond the EoL of the project.

The most important and beneficial EoL scenario is the reuse of existing assets, components or materials. Offering the potential for reuse in future, e.g. through providing appropriate flexibility or designing to enable deconstruction at EoL, will reduce future A1–A3 emissions and maximise the Module D benefits of your project. Additionally, reusing existing resources on your project will minimise A1–A3 emissions. Reuse of components requires design flexibility as you make use of an inventory of available parts that constrain and inform your design choices^{75–77}.

Designing to maximise recycling potential in future requires consideration of the impact of coatings, treatments, combining different materials into composites and the ease of dismantling components on recyclability.

Table 2.9: Module D carbon factors with corresponding EoL scenarios, taken from data sources used in Table 2.3 where Module D data is readily available

Material	Type	Specification/details	$ECF_{D,i}$ (kgCO ₂ e/ kg)	UK EoL scenario assumption	Data source
Concrete	<i>In situ</i> and precast	UK	-0.00123	90% recycling as aggregate	Refs. 19 and 74 ^{a,b}
Steel	Reinforcement bars	UK CARES sector average (EAF production), 97% recycled content	0.351	92% recycling	Ref. 22
		Global average Worldsteel LCI study	-0.819	85% recycling	Ref. 19
	PT strands	Assume the same as reinforcement bars			
	Structural sections and plate	UK (consumption average) Open rolled sections	-0.92	unknown	Ref. 26
		Global Open rolled sections	-0.283	85% recycling	Ref. 23
		UK and Global Closed sections	-1.53	92% recycling 7% reuse	Ref. 30
		UK and Global Plate	-1.28	85% recycling	Ref. 23
	Galvanised profiled sheet (e.g. for decking)	UK TATA ComFlor [®] decking average	-1.15	85% recycling	Ref. 38
		Global average Hot dip galvanised steel, Worldsteel LCI study	-1.26	85% recycling	Ref. 19
Blockwork	Module D data corresponding to ECF_{A13} data in Table 2.3 not readily available				
Brick	Single engineering brick	UK BDA generic brick	-0.016	90% recycling	Ref. 19
Stone	Module D data corresponding to ECF_{A13} data in Table 2.3 not readily available				
Timber ^c	Studwork/framing/ flooring	Softwood 100% FSC/PEFC	-0.524	55% recycling 44% incineration 1% landfill	Ref. 68 ^b
Aluminium	Sheet	European consumption, 31% recycled content	-3.09	95% recycling	Ref. 19
		Worldwide consumption, 31% recycled content	-8.69	85% recycling	Ref. 19
	Extruded	European consumption, 31% recycled content	-3.21	95% recycling	Ref. 19
		Worldwide consumption, 31% recycled content	-8.69	85% recycling	Ref. 19
Glass	Module D data corresponding to ECF_{A13} data in Table 2.3 not readily available				
Plasterboard	Module D data corresponding to ECF_{A13} data in Table 2.3 not readily available				

Notes:

^a The assumption of 90% recycling as aggregate is based on Ref. 74. Eqn. (2.9) has been applied to the data from Ref. 19 for recycled aggregate and UK average aggregate to yield $ECF_{D,i}: 0.9 \times ([\text{recycled aggregate ECF}] - [\text{UK average aggregate ECF}])$.

^b This EPD was not provided in Table 2.3, but has been included here as it contains information on Module D that the ICE database does not. The EPD does not provide the carbon factor for the different EoL scenarios separately.

^c Note that for timber, the EoL scenarios used for Module D must match those used for Modules C3–C4.

2.3 Process

2.3.1 Calculation

Figure 2.6: Calculating embodied carbon — process overview

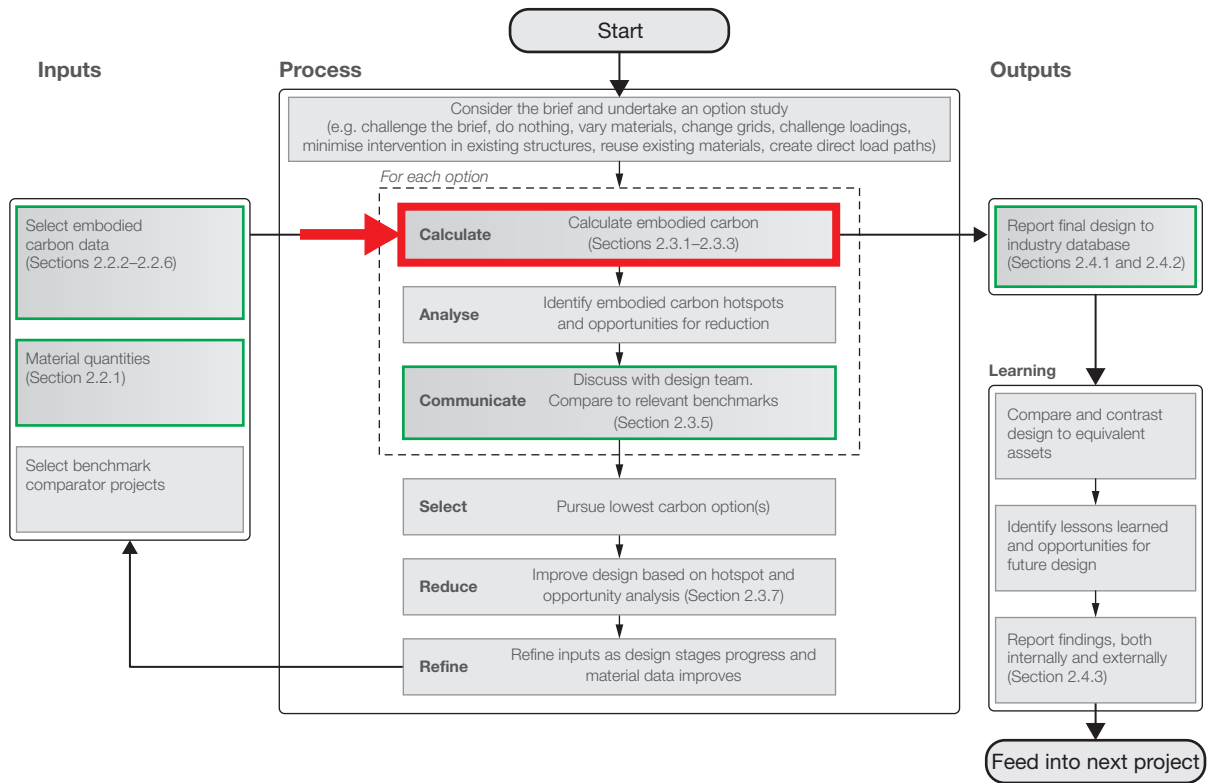

The fundamental principle of an embodied carbon calculation is to multiply the quantity of each material by its carbon factor.

The majority of embodied carbon for a building is typically associated with lifecycle Modules A1–A3 (cradle to factory gate), which also represent immediate emissions for which data is most readily available.

Calculating embodied carbon of different design options at early design stages is critical for reducing the embodied carbon of a project, while retrospective calculation of embodied carbon at the end of the design stages and at the end of construction is important for contributing your project data to industry benchmarking databases.

You should make embodied carbon calculations:

- Whenever there is a significant decision to be made, e.g. comparing structural framing and floor options in early design stages
- At the end of every stage of design
- At the end of the design process
- At the end of construction

Undertaking calculations at the end of construction is a vital step in improving future calculations. By collecting real information, you can improve the accuracy and reduce uncertainty around your future embodied carbon calculations during the design stages.

2.3.1.1 Modules A1–A3

A1–A3 emissions are the easiest to calculate, as the carbon factors are most readily available. They are also those that structural engineers have most immediate control over, and generally form most of the structural embodied carbon.

A1–A3 emissions are calculated by multiplying the quantities of each material by the A1–A3 carbon factor for each of those materials. The basic calculation is given in Equation (2.10):

$$EC_{A13} = \sum_{i=1}^n [Q_i(ECF_{A13,i})] \quad (2.10)$$

Where:

- EC_{A13} = total embodied carbon for life cycle Modules A1–A3 (kgCO₂e)
- Q_i = quantity of i^{th} material (kg)
- $ECF_{A13,i}$ = Modules A1–A3 embodied carbon factor for i^{th} material (kgCO₂e/kg)

Using Eqn. (2.10) you have calculated A1–A3 embodied carbon for all materials in your design.

- ⇒ Think about how to arrange your calculations, and whether you want to calculate embodied carbon by building element (each broken down into its constituent materials), or by material (with total quantities obtained from multiple building elements).
- ⇒ If you are using EPD specific data, make sure you check the functional or declared unit (for example, kg or m³), and match this to your calculation to ensure the units of EC_{A13} are output in kgCO₂e.

2.3.1.2 Modules A1–A5

Calculating the A1–A5 emissions (cradle to practical completion) is the minimum scope for a structural embodied carbon calculation (substructure and superstructure).

A1–A5 emissions are calculated in the same way as A1–A3 emissions, but additional carbon factors for material transport to site (A4) and material wastage on site (A5w) are included, plus an allowance for emissions associated with general construction activities. This calculation is given by Equation (2.11):

$$EC_{A15} = EC_{A13} + \sum_{i=1}^n [Q_i(ECF_{A4,i} + ECF_{A5w,i})] + EC_{A5a} \quad (2.11)$$

Where:

- EC_{A15} = total embodied carbon for life cycle Modules A1–A5 (kgCO₂e)
- EC_{A13} = total embodied carbon for life cycle Modules A1–A3 (kgCO₂e)
- Q_i = design quantity of i^{th} material (kg)
- $ECF_{A4,i}$ = transportation to site (Module A4) embodied carbon factor for i^{th} material, Eqn. (2.2)
- $ECF_{A5w,i}$ = on-site construction waste (Module A5) embodied carbon factor for i^{th} material, Eqn. (2.3)
- EC_{A5a} = construction activities emissions (Module A5), Eqn. (2.5)

As explained in Section 2.2.2.5, carbon sequestration associated with timber products should not be reported within the A1–A5 value, but reported separately alongside the A1–A5 total.

Using Eqn. (2.11) you have calculated A1–A5 embodied carbon (kgCO₂e) for your design. Total biogenic carbon sequestered must also be calculated and reported separately.

2.3.1.3 Modules A–C

A calculation that captures the carbon emissions over the asset's whole life cycle (cradle to grave) includes Module B (Use) and Module C (End of Life) in addition to Modules A1–A5.

In this guide we have focused on calculating product and construction stage embodied carbon (Modules A1–A5), as your immediate priority should be to minimise these emissions to address the climate emergency. Modules B and C relate to uncertain data points, and generally represent a small, but not insignificant, proportion of structural (superstructure and substructure) life cycle embodied carbon (unless timber products are used, Section 2.2.5.2) and the associated emissions may only occur in the distant future.

However, you should not dismiss life cycle Stages B, C and D, but instead acknowledge that consideration of the whole life cycle (Stages A–C plus D) is best practice for sustainable design.

At a minimum:

- ⇒ Coordinate with the design team to understand any interdependencies between structural design solutions and Stage B emissions associated with other design disciplines e.g. facades and MEP.
- ⇒ Be aware that Stage C and/or Stage D considerations can contribute to lower A1–A5 emissions of future projects.

In principle, the calculation for A–C is the same as for Modules A1–A5: find a carbon factor that represents the impact of each material at Modules B1–B5 and C1–C4 and multiply it by the respective material quantities.

The A–C calculation (including only Module B4 from Stage B for the reasons described in Section 2.2.5.1) is given by Equation (2.12):

$$EC_{AC} = EC_{A15} + \sum_{i=1}^n [Q_i(ECF_{B4,i} + ECF_{C2,i} + ECF_{C34,i})] + EC_{C1} \quad (2.12)$$

Where:

- EC_{AC} = total embodied carbon for life cycle Stages A–C (kgCO₂e)
- EC_{A15} = total embodied carbon for Modules A1–A5 (kgCO₂e)
- Q_i = quantity of i^{th} material (kg)
- $ECF_{B4,i}$ = replacement (Module B4) embodied carbon factor for the i^{th} material (kgCO₂e/kg) (Eqn. (2.6))
- $ECF_{C2,i}$ = transportation away from site at EoL (Module C2) embodied carbon factor for i^{th} material (kgCO₂e/kg) (Section 2.2.5.2.2)
- $ECF_{C34,i}$ = waste processing and disposal (Modules C3 and C4) embodied carbon factor for i^{th} material (kgCO₂e/kg) (Section 2.2.5.2.3)
- EC_{C1} = demolition and deconstruction (Module C1) activities emissions (kgCO₂e) (Section 2.2.5.2.1)

Using Eqn. (2.12) you have calculated Stage A–C embodied carbon (kgCO₂e) for your design.

2.3.1.4 Module D

Benefits and burdens from reuse, recovery and recycling of materials after the life of the building (Module D) must always be reported separately to all other life cycle stages.

Assessing Module D can contribute to quantifying holistic environmental impact and provide a measure of circularity of a project.

It can be calculated in the same way as A1–A3 emissions: multiply the material quantity by an emissions factor, Equation (2.13):

$$EC_D = \sum_{i=1}^n [Q_i(ECF_{D,i})] \quad (2.13)$$

Where:

EC_D = total embodied carbon for Module D
 Q_i = quantity of i^{th} material (kg)
 $ECF_{D,i}$ = embodied carbon factor for Module D of i^{th} material

You should work with your design team to develop project specific scenarios for the possible future use of components beyond EoL. A single project may have multiple scenarios, and each should be realistic and feasible. Explore each scenario thoroughly and report it clearly within the carbon section of your design stage report.

2.3.2 Normalising results

In addition to considering total carbon values, calculations results should be normalised:

- **For all projects:** by the functional unit of the asset that describes the performance characteristics of the system¹⁰, e.g. net internal area (NIA) for offices and residential; functional deck area for bridges; km for roads, railway lines, power lines and pipelines; number of spectator seats or enclosed area for stadia¹
- **Additionally, for buildings:** by the gross internal area (GIA)⁶⁷. For buildings projects, embodied carbon is most commonly quoted as a kgCO₂e/m² GIA figure

This is to ensure fair and meaningful comparisons with projects of the same type, reflecting the efficiency of the asset's use.

⇒ Remember that when comparing options, the embodied carbon results should be normalised in the same way.

GIA is the area of a building measured to the internal face of the perimeter walls at each floor level⁶⁷.

NIA is the usable area within a building measured to the internal face of the perimeter walls at each floor level. This excludes, for example, stairwells, corridors and mechanical areas⁶⁷.

Roof areas that are not permanently covered are not included in GIA. Although this can make very low-rise construction more carbon intensive per GIA when compared to taller developments, this may reflect the efficiency of the development in terms of usable space throughout a year.

For refurbishment projects the total embodied carbon should be divided by the GIA (and other functional equivalent) of the refurbished building including any new and existing floor area. This can be used to demonstrate the benefit of refurbishment over demolition and rebuild.

Now you will have values for the total embodied carbon (kgCO₂e) and normalised embodied carbon (e.g. in kgCO₂e/m² GIA) for, as a minimum, life cycle Modules A1–A5.

2.3.3 Sense check

Studies^{78,79} have shown that business as usual construction for embodied carbon to practical completion (Modules A1–A5) for substructure plus superstructure in buildings typically ranges **between 150–400kgCO₂e/m² GIA**. This corresponds to a SCORS rating⁴ of B to G.

Studies by COWI⁸⁰ shows that the equivalent range for bridges is typically between 1,000–4,000kgCO₂e/m² functional area.

Where your project sits relative to this range will be influenced by a number of variables that affect material quantities, in addition to the carbon factors chosen. These include but are not limited to: basement size; architectural form; requirement for transfer structures; typical span; number of storeys; building use (loading requirements); framing and floor type; ground conditions and location in relation to natural hazards. It is therefore important to note any project specific design considerations when reporting embodied carbon (Sections 2.3.5 and 2.4). Refer to Section 2.3.7 to make sure your project is at the lowest end of the range possible for embodied carbon.

Publicly available information on embodied carbon of structures is very limited, so to improve this and our understanding of embodied carbon in our designs, all structural engineers should share their embodied carbon data with the industry (Section 2.4.1).

2.3.4 Uncertainty

Uncertainty must not deter you from undertaking embodied carbon calculations.

Calculations of embodied carbon incorporate uncertainty to varying degrees for each lifecycle stage/module, and at different design stages. Sources of uncertainty are:

- Material quantities, Q_i
- Embodied carbon factors, ECF_i , for materials and processes

At concept stages, you may be making assumptions about material quantities in addition to material specifications. The possible range of embodied carbon could be significant. As projects progress, material quantities will become more accurate as detailed design is undertaken. Similarly, increasing certainty around material specifications and specific product sourcing as projects progress will allow ECFs to move from generic values to specific values, thereby increasing the accuracy of your assessment. Be aware of the uncertainty in the data when reporting embodied carbon.

⇒ This uncertainty must not deter you from undertaking embodied carbon calculations. Instead, note in your reports and calculations the sources of uncertainty, and use the open reporting of data to help reduce it.

A simple example is Module A5a — site activities. Eqn. (2.5) allows you to calculate A5a emissions based on a construction activities emissions factor related only to the total project cost. If every construction site recorded actual on-site electricity and fuel consumption and reported this as part of their as-built calculation, a more accurate picture of Module A5a could be created to improve future Module A5a calculations.

⇒ To reflect the level of uncertainty of your calculation you may wish to consider the number of significant figures you report your result to. This is to avoid unintentionally communicating that there is more accuracy than there is. One suggestion could be rounding to the closest tCO₂e, or the closest kgCO₂e/m². In addition, you could report the range of values, for example 100kCO₂e/m² ± 20%. If comparing two options with different levels of uncertainty, reporting a range of values can inform the decision-making process.

2.3.5 Communicate and discuss embodied carbon

Figure 2.7: Calculating embodied carbon — process overview

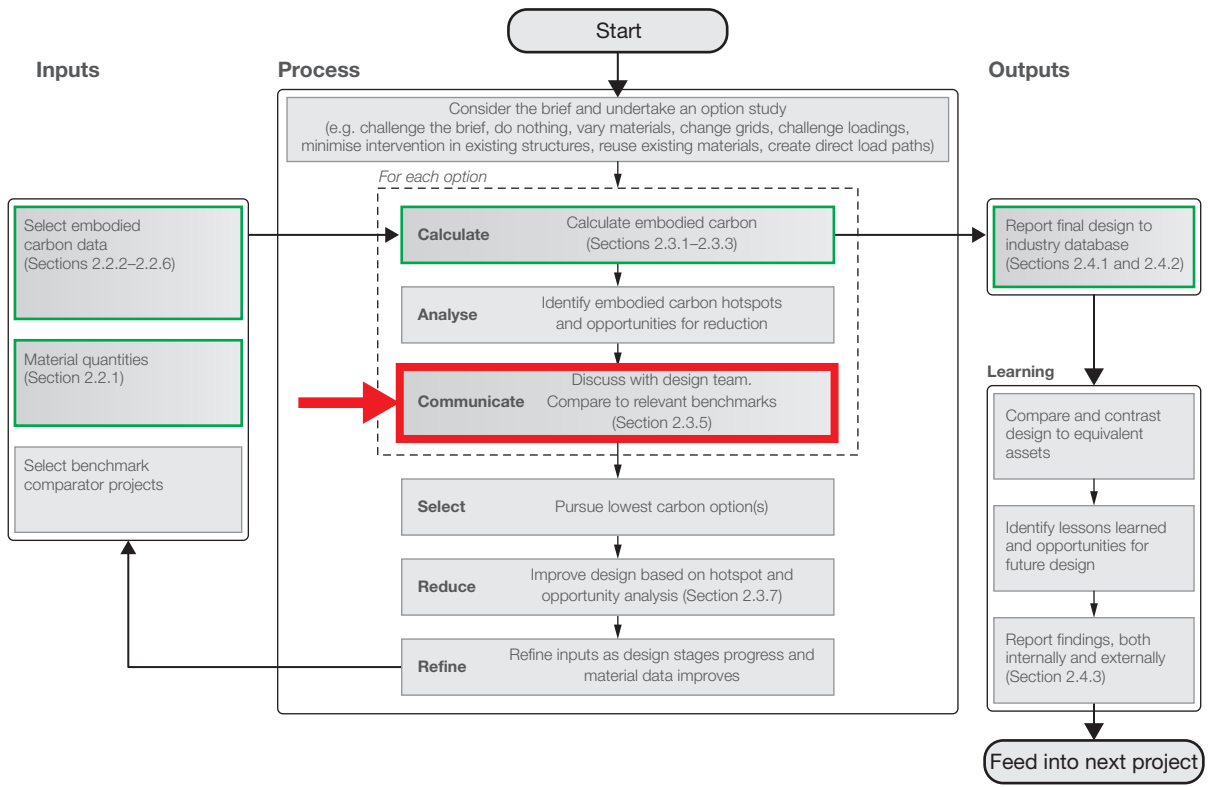

It is essential that embodied carbon assessments inform the design process. Your calculations must be discussed with the design team, and form part of the agenda for design workshops.

⇒ You should regularly communicate and discuss results with your team. Include embodied carbon information in your stage reports, in client and design team presentations, and on your design drawings.

It is strongly recommended that your design team hosts an embodied carbon workshop at least at the start of:

- Concept design (i.e. RIBA Stage 2)
- Developed design (i.e. RIBA Stage 3)
- Technical design (i.e. RIBA Stage 4)
- Construction (i.e. RIBA Stage 5)

In these workshops:

- Discuss opportunities for embodied carbon reduction based on the embodied carbon assessment carried out during the previous work stage
- Create a strategy to implement these opportunities

Be ambitious and advocate to the client that the reduction strategies be implemented.

When discussing embodied carbon in any workshops, discussions or presentations with your project team, remember the following key points:

- **As a minimum, report Modules A1–A3, A4 and A5** (Section 2.1.1)
- For transparency, report module results separately as well as aggregated
- If reporting aggregated A–C results, report aggregated A1–A5 results to highlight the contribution of emissions up to practical completion. Section 2.1.1 explains the reasons for this
- Do not aggregate Module D results with Stage A–C results — report Module D separately
- If the scope of your calculation is A1–A5, and if using any timber products in your design, sequestration benefits should be reported separately alongside the total A1–A5 embodied carbon result (Section 2.2.2.5)
- Clearly state the units of normalisation, if applicable, e.g. m² GIA (Section 2.3.2)
- It can be helpful to report total carbon values alongside any normalised carbon values
- Clearly state the scope of calculation, addressing life cycle modules and elements assessed (Section 2.1)

This makes calculations transparent, easily understandable, easily comparable and allows the design team to keep a clear audit trail of the carbon parameters used in calculations.

Transparency of calculation scope is key to enabling meaningful comparisons and discussions with the design team.

⇒ If the scope of your calculation includes Stages A–C, it is recommended to report the A1–A5 result alongside the total A–C result on presentations and drawings. This helps to communicate the time dependency of emissions over the asset life cycle and highlight upfront emissions.

Figure 2.8 shows examples of clear presentation of embodied carbon calculation results for inclusion as a thumbnail on a drawing, sketch or presentation to the project team — one for a scope of A1–A5 (top) and one for a scope of A–C (bottom). It clearly states the calculation scope and units of normalisation.

For full transparency, an example of a more comprehensive range of assessment information, e.g. to be presented in design stage reports, is shown in Table 2.10.

2.3.5.1 Understanding interdependencies and whole life carbon impacts

Although A1–A5 is the minimum scope for a structural embodied carbon assessment, it is important to understand how different structural design solutions affect whole building carbon emissions over the lifetime of the building. This is achieved through coordination with the rest of the design team and an understanding of the interdependencies between the design of different building elements. For example, the interdependencies between the structural design and the following building elements should be checked:

- Services — for Modules B6–B8
- Facade systems — for Modules A1–A5, B4 and B6
- Architectural finishes, e.g. ceilings and floors — for Modules A1–A5 and B4
- Fire protection — for Modules A1–A5 and B4
- User carbon — for infrastructure, Module B9

This approach will engage the whole design team in minimising whole building carbon emissions over the asset life cycle and avoid unintended consequences of minimising structural embodied carbon.

Figure 2.8: Example of brief, clear and transparent presentation of A1–A5 embodied carbon (top) and A–C embodied carbon (bottom) for drawings, sketches or presentations[†]

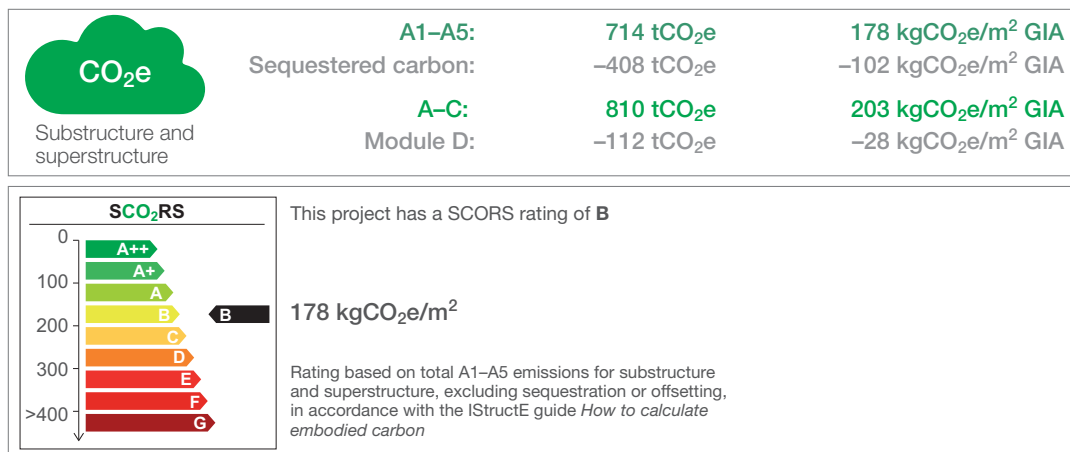

Table 2.10: Comprehensive data for inclusion in an embodied carbon assessment report⁷

Assessment information	
Date of assessment	e.g. 27/02/2022
Project stage	Design or construction stage at time of calculation
Verified by	Verifier name and organisation
Project type	e.g. New build or refurbishment of existing structure
Project location	Address, or provide the w3w location e.g. https://w3w.co/mild.path.yards
Date of project completion	Estimate if not known, e.g. 01/05/2023 (estimated)
Asset type	e.g. Residential, public/civic, retail, office, road bridge, rail bridge, station, etc. For buildings, state planning use class
Brief description	e.g. No. storeys (below and above ground level), structural frame type, bridge structure, brief description of other notable features that have impacted project embodied carbon
Size	Functional units, e.g. GIA, NIA, functional bridge deck area, volume, seating capacity, etc.
Project design life	Building default: 60 years, infrastructure default: 120 years ⁷
Modules included	e.g. A1, A2, A3, A4, A5 (BS EN 15978) ⁵
Building elements included	Infrastructure: N/A Buildings: Refer to Table 2.1 for minimum scope of structural elements to include
Assumptions and scenarios	List all assumptions and scenarios used in the assessment, including brief justifications where appropriate
Primary carbon factor source	e.g. ICE database ¹⁹ , EPDs

[†] In line with the guidance given in Section 2.2.2.5, sequestration has been reported separately to A1–A5 where only A1–A5 is assessed. It is included within the totals reported where A–C is assessed.

2.3.6 Calculation tools

The calculation of embodied carbon can become complicated where multiple materials, components and carbon factors are involved. Tools to assist in the calculation are available, and some are listed in Table 2.11. Note that some only cover Modules A1–A3. It is up to you to determine which tool best suits your needs.

Table 2.11: Selection of embodied carbon calculation tools (others available not listed here)

Type	Name	Scope	Applicable geographical regions	BIM plug-in functionality?	Link
Free at point of use	The Structural Carbon Tool	A1–A3	Global	No	https://carbon.tips/tsct
	Beacon	A1–A3	USA	Yes	https://carbon.tips/beacon
	EC3	A1–A3	USA	No	https://carbon.tips/ec3
	Hawkins\Brown Emission Reduction Toolkit (H\BERT)	A–D	UK	Yes	https://carbon.tips/hbert
	OneClick LCA Planetary	A1–A3	Many (incl. UK)	No	https://carbon.tips/planet
	eTool ‘open use’ subscription	A–D	Global	No	https://carbon.tips/etool
	RSSB Rail Carbon Tool	N/A	UK	No	https://carbon.tips/rssb
	Environment Agency – ERIC	A1–A5	UK	No	https://carbon.tips/cpt
	Athena	A1–A5, B4, B6, C1, C2, C4, D	USA and Canada	No	https://carbon.tips/athena
Paid	OneClick LCA	A–D	Global	Yes	https://carbon.tips/oneclick
	eTool (paid version)	A–D	Global	Yes	https://carbon.tips/etool
	Tally	A–D	USA	Yes	https://carbon.tips/tally
	ECCOlab	A–C	UK	No	https://carbon.tips/eccolab

Note: Check link to see which countries this tool is available in.

If there is no tool appropriate for your use, refer to Table 2.3 for a list of available A1–A3 carbon factors for the UK (Appendix A for other A1–A3 carbon factor data sources) for you to use to create your own calculation using the information presented in this guide.

2.3.7 Reducing embodied carbon

Embodied carbon calculations should be used to inform targeted design decisions that reduce carbon emissions, with an ambition to reduce whole life carbon of all assets to zero.

CO₂ reductions today will result in a higher probability of limiting warming to 1.5°C⁸¹. Therefore, it is important to reduce emissions in the very near term (i.e. upfront carbon) as quickly as we can¹³.

When considering a design, a suggested hierarchy for carbon reductions is illustrated in Figure 2.9 and Table 2.12, adapted from the PAS 2080¹⁰ framework for integrating carbon reductions into the design process for infrastructure projects. LETI’s *Embodied Carbon Primer*¹¹ also provides useful rules of thumb embodied carbon reduction strategies.

Figure 2.9: Carbon reduction potential over time

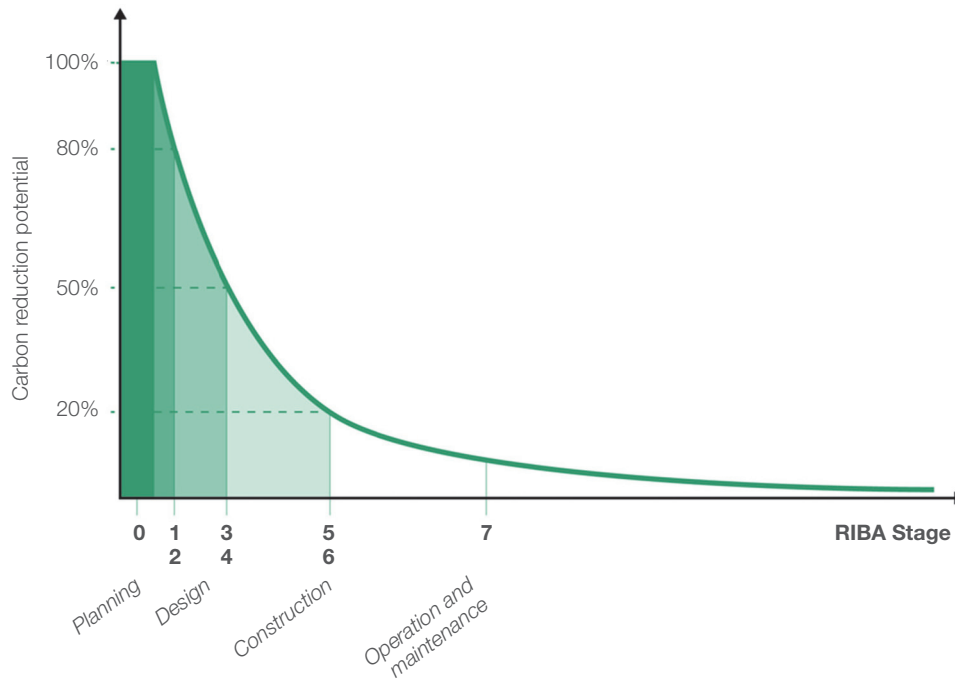

Table 2.12: A suggested hierarchy for carbon emissions reduction based on PAS 2080¹⁰

Hierarchy	Description	Example design levers
Build nothing	Evaluate the basic need for an asset and consider whether any new construction is needed	Challenge the brief and propose alternatives. Improve utilisation of existing floor areas
Build less	Minimise demand for new construction: reuse, repurpose and refurbish existing assets and minimise extension sizes	Justify existing structures through analysis and surveying. Maximise usage efficiency of the existing asset and any new construction that may be required
Build clever	Make low carbon solutions (technologies, materials and products) your default option. Specify enough material and no more	Design to minimum loads (within code allowance), set realistic SLS criteria, set utilisation ratios to 1, reduce structural grids, spans and transfer structures, use efficient structural forms, low carbon material choices, low carbon material specifications and suppliers, reuse existing materials where possible
Build efficiently	Use of construction techniques to reduce resource consumption	Utilise temporary structures in the permanent condition, avoid over-ordering, do not allow possible site errors to alter design choices. Monitor construction emissions. Design to enable offsite manufacture to reduce waste on site

2.4 Outputs

Reporting project embodied carbon data to a publicly accessible database is vital to enable the development of benchmarks that can be used to inform embodied carbon targets for future legislation, and improve industry understanding of embodied carbon in the built environment.

A key tenet of resolving the climate emergency is a commitment to openly sharing data and best practice that can help us all to reach zero carbon. **It is therefore essential that embodied carbon data on all projects is reported in an open-source and upfront manner.** This data will help to identify best practice, refine targets and identify opportunities in implementing significant embodied carbon reduction.

2.4.1 Reporting publicly

Figure 2.10: Calculating embodied carbon — process overview

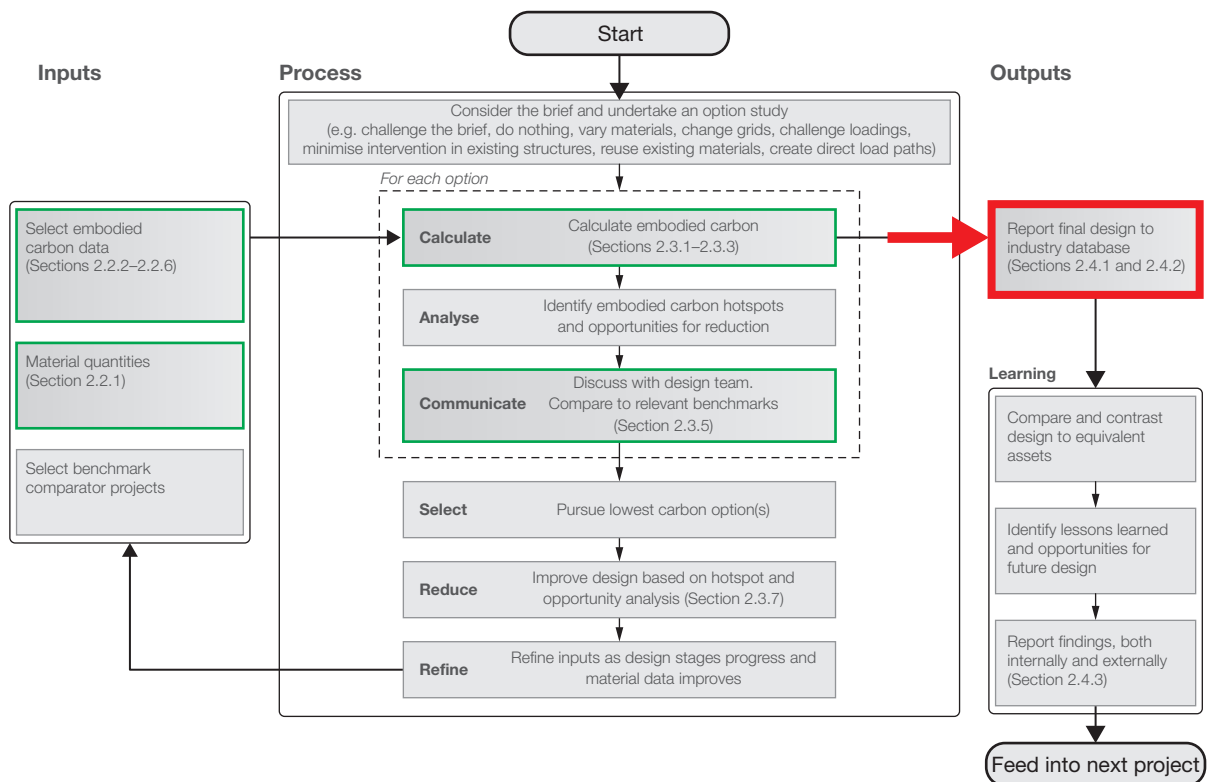

In the UK, we recommend making use of the Built Environment Carbon Database (BECD) which is being developed and due to launch in 2022⁸². On launching, this will be the only freely accessible industry-wide project carbon database in the UK. An easy way to upload information to the database is via the excel upload template spreadsheet which can be downloaded from the website.

- ⇒ It is strongly recommended that all embodied carbon calculation tools are adjusted to enable outputs in this format for quick uploading to the database.
- ⇒ It is best practice to report material quantity data alongside embodied carbon calculations to aid transparency.

Entries to the BECD can be made anonymously and anyone can sign up. This public reporting should be made:

- At the end of the design stage (i.e. end of RIBA Stage 4)
- At the end of construction (based on as-built information)
- By a selected individual or group within your organisation to make the process of uploading data more efficient and consistent. This individual or group should take responsibility for verifying the data before uploading to the database, whether or not the database already has a data verification procedure in place

⇒ The results of the end of design stage calculation and the end of construction calculation are unlikely to be the same. Analyse the differences to help improve your understanding of embodied carbon in built structures for the next project you work on.

2.4.2 As-built calculation

The as-built calculation should be the most accurate measure of the true embodied carbon to practical completion (Modules A1–A5) of a project, as the specification and origin (for Modules A1–A3) of each product and material delivered to site, and therefore transportation mode and distance (for Module A4), will be known in detail. On-site material waste tracking and construction activity energy metering will inform a more precise Module A5 value.

The calculation of an as-built carbon value relies on close cooperation with the main contractor through design and construction.

⇒ Wherever possible the main contractor's scope of work should include such monitoring and analysis. Site delivery and carbon tracking software⁸³ may be of use in such tracking activities.

2.4.3 Share case studies

Sharing case studies that highlight lessons learned in embodied carbon reduction is a key component of the climate emergency response. *The Structural Engineer* magazine welcomes case studies (large or small) on this topic, for consideration. Please send your case studies to tse@istructe.org.

3 Conclusions

This guide provides a common set of embodied carbon calculation principles for the structural engineering community to follow. The calculation of embodied carbon must now become a key part of every design process — to support our immediate need to reduce resource demand, increase reuse and recycling, and enable a circular economy.

While the calculation is simple, there remain many sources of uncertainty. The majority of our built assets have not been subjected to whole life carbon assessments, and so we currently have relatively little data on what current practice is achieving. Yet we must not be deterred from calculating embodied carbon because of uncertainty of carbon factors. Instead, through widespread measurement and open reporting of our calculation, we will collectively be able to reduce this uncertainty and reduce our climate impact.

As this information is generated, our ability to set reduction targets and benchmarks will improve. The measurement and reporting of embodied carbon data thus creates a virtuous circle that reduces our uncertainty around what good design looks like and helps all design teams to improve their climate emergency response.

The Institution of Structural Engineers recognises the importance of addressing the climate emergency. The climate emergency declaration⁸⁴ recognises the importance of a swift response from structural engineering, and signatories seek to:

- Raise awareness of the climate and biodiversity emergencies and the urgent need for action amongst our clients, collaborators and supply chains
- Advocate for faster change in our industry towards regenerative design practices and a higher Governmental funding priority to support this
- Establish climate and biodiversity mitigation principles as a key measure of our industry's success: demonstrated through awards, prizes and listings
- Share knowledge and research to that end on an open-source basis
- Evaluate all new projects against the aspiration to contribute positively to mitigating climate breakdown and encourage our clients to adopt this approach
- Upgrade existing buildings for extended use as a more carbon efficient alternative to demolition and new build whenever there is a viable choice
- Include life cycle costing, whole life carbon modelling and post occupancy evaluation as part of the basic scope of work, to reduce both embodied and operational resource use
- Adopt more regenerative design principles in practice, with the aim of providing structural engineering design that achieves the standard of net zero carbon
- Collaborate with clients, architects, engineers and contractors to further reduce construction waste
- Accelerate the shift to low embodied carbon materials in all our work
- Minimise wasteful use of resources in our structural engineering design, both in quantum and in detail

We hope that every structural engineering practice operating in the UK will join us in making this commitment. Visit www.istructe.org/structural-engineers-declare to find out how your company can sign up.

Appendix A: Carbon factor databases

Carbon data can be obtained from a variety of sources. Table A1 provides a list of such sources, based on publications from the EU Level(s) project⁸⁵. Designers working in the UK are recommended to use the data provided in this guide, and the ICE database¹⁹ for any A1–A3 carbon factors not covered.

If there is a body of carbon factor data for a specific country that is not referenced here, please go to <https://carbon.tips/database> and provide the information to be included in the next edition of this guidance.

Table A1: Life cycle assessment material/product carbon factor databases

Region	Database	Notes	Link
Europe			
UK	Built Environment Carbon Database (product-level database)	Free online database developed by a consortium of built environment institutions to collect UK EPD data. Beta version launching 2022	www.becd.co.uk
UK	ICE database	Wide-ranging material database covering Modules A1–A3	https://carbon.tips/ice3
UK	BRE Verified BS EN 15804 EPD	EPDs for specific products, with a range of modules	https://carbon.tips/breEPD
UK	BRE IMPACT	350 BS EN 15804-compliant datasets modelled in SimaPro	https://carbon.tips/umx
Europe	European Aluminium EPD Programme	EPDs for specific aluminium products, with a range of modules	https://carbon.tips/lca8
France	Environmental and health reference data for building construction products	EPDs for a range of building construction products, in French	https://carbon.tips/lca33
Germany	Oekobaudat	EPDs for a range of building products	https://carbon.tips/lca15
Germany	IBU	EPDs for specific products, in German. Requires registration	https://carbon.tips/lca17
Ireland	Irish Green Building Council	Generic data for 15 building materials on the Irish market	https://carbon.tips/igbc
Italy	EPD Italy	EPDs for specific products	https://carbon.tips/lca19
Norway	EPD Norge	EPDs for specific products	https://carbon.tips/lca18
Spain	DAP construcción	EPDs for specific products	https://carbon.tips/lca21
Sweden	International EPD	EPDs for specific products	https://carbon.tips/lca22
Switzerland	Ecoinvent	Paid database	https://carbon.tips/lca23

Table A1: Continued

Region	Database	Notes	Link
North America			
Canada	CSA EPD	EPDs for specific products, some not available for immediate download	https://carbon.tips/lca2
Canada	CRMD	Requires registration. Small number of carbon emission data points	https://carbon.tips/lca3
USA	ASTM EPD	EPDs for specific products	https://carbon.tips/lca4
USA	EC3	EPDs for specific products	https://carbon.tips/4hv
Asia			
Turkey	EPD Turkey	EPDs for specific products	https://carbon.tips/lca27
Australia/Oceania			
Australia	EPiC database	Wide-ranging material database covering Modules A1–A3 for 250 materials	https://carbon.tips/epic
Australia, New Zealand	Australasian EPD	EPDs for specific products	https://carbon.tips/lca29
New Zealand	Branz CO2NSTRUCT	Calculation sheet, using data from specific EPDs along with general databases	https://carbon.tips/lca34
South America			
Latin America	EPD Latin America	EPDs for specific products	https://carbon.tips/lca31

Appendix B: Example calculation

A single-storey pavilion structure (Figure B1) has a gross internal area (GIA) of 792m² and a total construction value of £800,000. The structure will be built in the UK, and no replacement or repair of any structural elements are expected during the life of the structure. This appendix demonstrates a typical carbon calculation to estimate both the upfront and whole life carbon of the structure, the output of which is summarised in Figure B2. The calculation was then repeated using *The Structural Carbon Tool*³, and a screenshot of the output is provided as Figure B3.

Figure B1: Single-storey structure: concept design

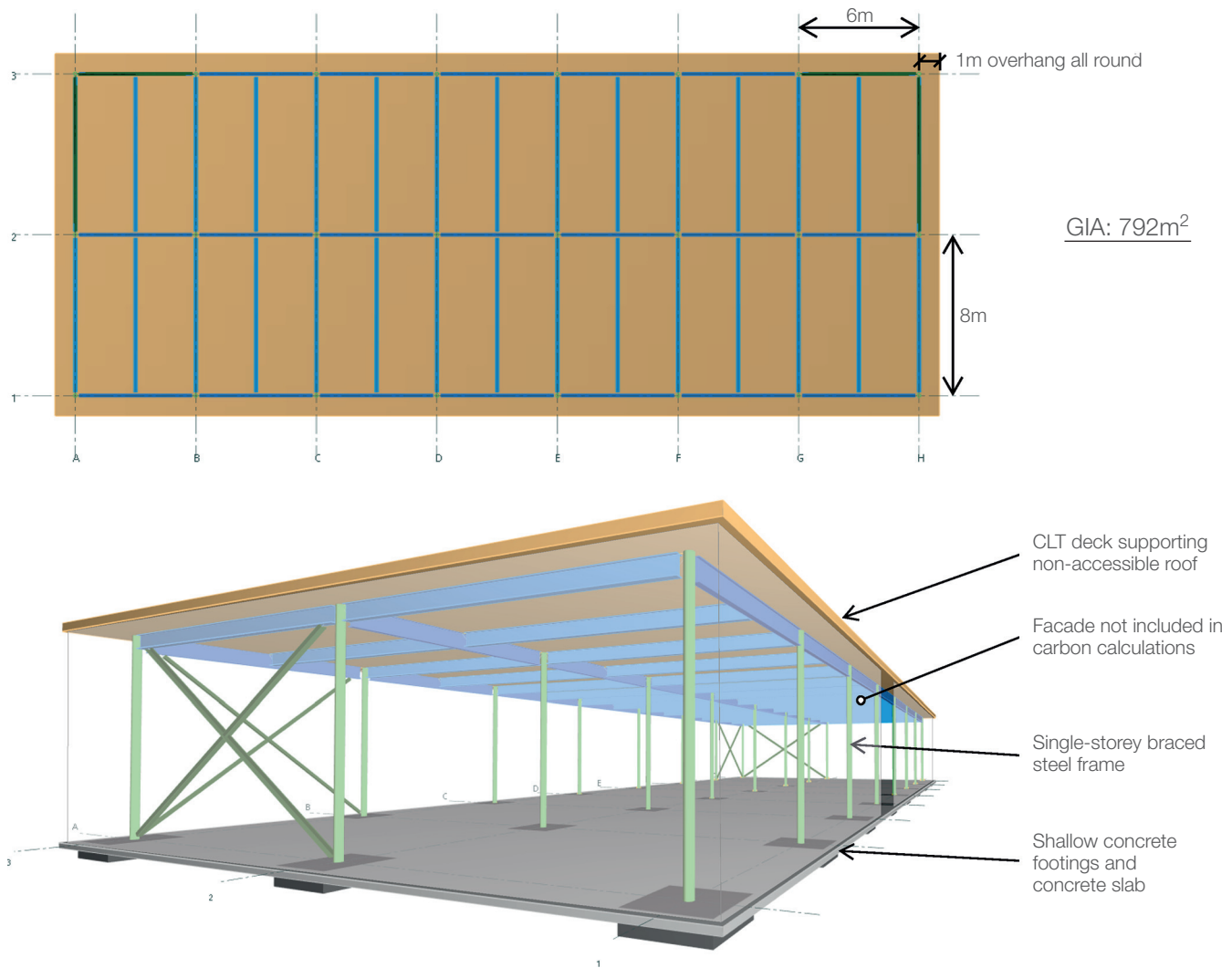

Inputs

Quantities

Reinforced concrete: foundations and ground-bearing slab

Ground-bearing slab: assume 120mm slab, across a GIA of $792\text{m}^2 = 95.0\text{m}^3$

Footings: 24No. pads, assume 1.5m^2 , 600mm thick = 21.6m^3

Rebar: assume 90kg per m^3 of concrete (inc. laps) throughout

Mass of concrete = $2,400\text{kg}/\text{m}^3 \times (95.0 + 21.6) = 279.8\text{t}$

Mass of rebar = $90\text{kg}/\text{m}^3 \times (95.0 + 21.6) = 10.5\text{t}$

Steel: frame

For whole frame, assume $40\text{kg}/\text{m}^2$, including connections, at a GIA of 792m^2

Mass of steelwork = $40\text{kg}/\text{m}^2 \times 792 = 31.7\text{t}$

CLT: roof slab

CLT planks: assume 150mm thick, over full roof area of $896\text{m}^2 = 134.4\text{m}^3$

Mass of CLT = $465\text{kg}/\text{m}^2 \times 134.4 = 62.5\text{t}$

Carbon factors

All factors taken from this guidance.

Reinforced concrete: foundations and ground-bearing slab

Concrete:

A1–A3 (production): $0.100\text{kgCO}_2\text{e}/\text{kg}$ (RC25/30, 25% GGBS, Table 2.3)

A4 (transport): $0.005\text{kgCO}_2\text{e}/\text{kg}$ (assume local, Table 2.5)

A5w (waste): $0.053 \times (0.100 + 0.005 + 0.005 + 0.013) = 0.007$ (Eqn. 2.3, Table 2.6)

Rebar:

A1–A3 (production): $0.760\text{kgCO}_2\text{e}/\text{kg}$ (UK CARES average, Table 2.3)

A4 (transport): $0.032\text{kgCO}_2\text{e}/\text{kg}$ (assume UK manufacture, Table 2.5)

A5w (waste): $0.053 \times (0.760 + 0.032 + 0.005 + 0.013) = 0.043$ (Eqn. 2.3, Table 2.6)

Steel: frame

A1–A3 (production): $1.740\text{kgCO}_2\text{e}/\text{kg}$ (UK rolled open sections, Table 2.3)

A4 (transport): $0.032\text{kgCO}_2\text{e}/\text{kg}$ (assume UK manufacture, Table 2.5)

A5w (waste): $0.010 \times (1.740 + 0.032 + 0.005 + 0.013) = 0.018$ (Eqn. 2.3, Table 2.6)

CLT: roof slab

A1–A3 (production): $0.250\text{kgCO}_2\text{e}/\text{kg}$ (European production average, Table 2.3)

Biogenic sequestration: $-1.640\text{kgCO}_2\text{e}/\text{kg}$

A4 (transport): $0.161\text{kgCO}_2\text{e}/\text{kg}$ (assume European manufacture, Table 2.5)

C3–C4 (end of life): $1.66\text{kgCO}_2\text{e}/\text{kg}$ (UK EoL scenario, Table 2.8)

A5w (waste): $0.010 \times (0.250 + 0.161 + 0.005 + (-1.640) + 1.662) = 0.004$ (Eqn. 2.3, Table 2.6)

Calculations

Upfront carbon (Modules A1–A5)

Reinforced concrete: foundations and ground-bearing slab

Cradle to completion (A1–A5) = $[279.8\text{t} \times (0.100 + 0.005 + 0.007)] + [10.5\text{t} \times (0.760 + 0.032 + 0.043)] = 40\text{tCO}_2\text{e}$

Steel: frame

Cradle to completion (A1–A5) = $31.7t \times (1.740 + 0.032 + 0.018) = 57tCO_2e$

CLT: roof slab

Cradle to completion (A1–A5) = $62.5t \times (0.250 + 0.161 + 0.004) = 26tCO_2e$

Sequestered biogenic carbon = $62.5t \times -1.640 = -103tCO_2e$

Whole-building emissions

Site activities (A5a) = $700kgCO_2e/£100,000 \times £800,000 = 6tCO_2e$

Other stages

Whole-building emissions

Demolition and deconstruction (C1) = $3.4kgCO_2e/m^2 \times 792m^2 = 3tCO_2e$

Reinforced concrete: foundations and ground-bearing slab

C2–C4 (end of life) = $[279.8t \times (0.005 + 0.013)] + [10.5t \times (0.005 + 0.013)] = 5tCO_2e$

Steel: frame

C2–C4 (end of life) = $31.7t \times (0.005 + 0.013) = 1tCO_2e$

CLT: roof slab

C2–C4 (end of life) = $62.5t \times (0.005 + 1.662) = 104tCO_2e$

Results

Estimate of overall carbon footprint for pavilion, based on GIA of 792m².

Upfront carbon (A1–A5) = sum A1–A5 for all materials = 129tCO₂e
= **163kgCO₂e/m²**

Biogenic sequestration = -102tCO₂e
= **-129kgCO₂e/m²**

Whole life carbon (A–C) = sum A1–C4 + sequestration = 139tCO₂e
= **176kgCO₂e/m²**

Figure B2: Single-storey structure SCORS rating sticker⁴

 Substructure and superstructure	A1–A5:	129 tCO₂e	163 kgCO₂e/m² GIA
	Sequestered carbon:	-102 tCO₂e	-129 kgCO₂e/m² GIA
	A–C:	139 tCO₂e	176 kgCO₂e/m² GIA
	Module D:	-58 tCO₂e	-73 kgCO₂e/m² GIA

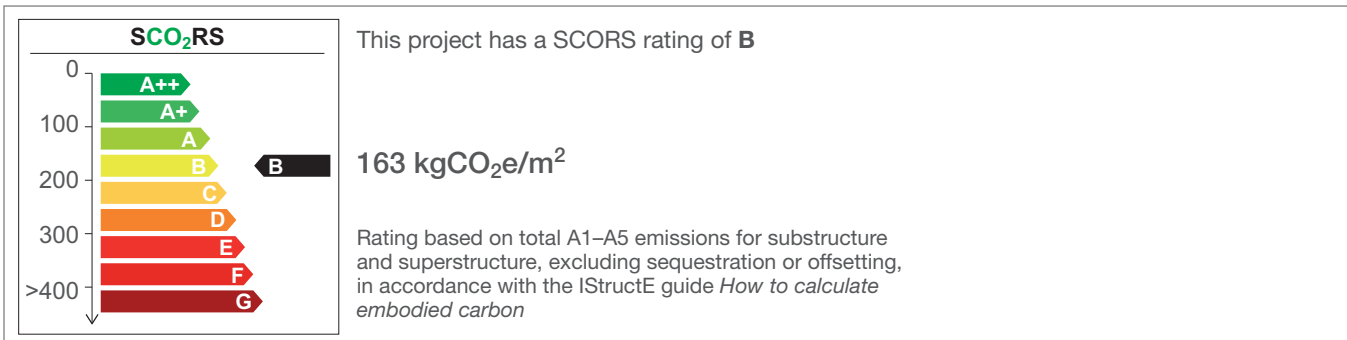

Figure B3: Single-storey structure calculation using *The Structural Carbon Tool*

TSCT v2.0 Scheme name: Single storey concept structure The Institution of Structural Engineers

Material	Material type	Material specification	Structural element	Description	Component lifespan (years)	Temporary works	% of temp works wasted	Volume (m ³) or mass (kg)?	Material quantity (m ³ , kg)	Reinforcement (kg/m ³)	Element embodied carbon [tCO ₂ e]	A1-A3	A4	A5w	B4	C2-C4	D	Biogenic carbon	
Concrete	In situ	UK C25/30 (25% GGBS)	1.1 Lowest floor/slab	120mm ground-bearing slab	60	No		Volume (m ³)	95	Custom 1 (90)	36.8	29.3	1.4	1.9		4.3	3.0		
Concrete	In situ	UK C25/30 (25% GGBS)	1.1 Foundations (incl. pile caps)	24no. 1.5m ² x 600mm pads	60	No		Volume (m ³)	22	Custom 1 (90)	8.4	6.7	0.3	0.4		1.0	0.7		
Steel	Structural_sections	UK rolled open sections	2.1 Frame	Assume 40kg/m ² inc conns	60	No		Mass [kg]	31,690		57.3	55.1	1.0	0.6		0.6	-29.1		
Timber	Manufactured_structural_timber	UK CLT 100% FSC/PEFC	2.3 Roof	150mm CLT slab	60	No		Volume (m ³)	134		27.6	15.6	10.1	0.3		104.2	-32.7	-102.5	
1.1 Excavation-Foundation											1.0								
1.1 Excavation-Other																			

CO₂e

Substructure & Superstructure

A1-A5: 129 tCO₂e 163 kgCO₂e/m²

Biogenic carbon: -102 tCO₂e -129 kgCO₂e/m²

A-C: 139 tCO₂e 176 kgCO₂e/m²

Module D: -58 tCO₂e -73 kgCO₂e/m²

	A5a	C1
Global Values	6	3

	A	B	C	D	Biogenic
Total [tCO ₂ e]	129	0	113	-58	-102

Single-storey concept structure – Element emission breakdown [tCO₂e]

- Piling (1.1)
- Other substructure (1.1)
- Frame and roof frame (2.1, 2.3)
- Upper floors/slabs inc. roof (2.2, 2.3)
- Structural walls (2.5, 2.7)
- Other

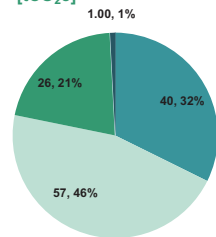

This project scheme releases carbon equivalent to:



152 one-way flights from London to New York



76 people's consumption of meat, dairy and beer for 1 year



42 average family cars running for 1 year

Scheme performance against targets:

SCORS: 137kgCO₂e/m² Scheme does not meet target
RIBA: 156kgCO₂e/m² Scheme does not meet target

This project scheme has a SCORS rating of B

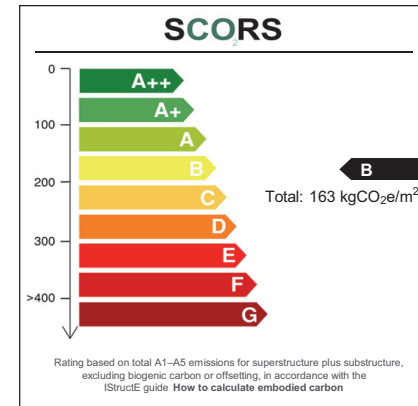

The Structural Carbon Tool was produced by Elliott Wood Partnership Limited in partnership with The Institution of Structural Engineers.

Appendix C: Supplementary information for bridges

This bridge-specific appendix is provided as a complementary resource — to recommend amendments and provide further detail where there is a practical difference between the embodied carbon calculation process for general building structures (the focus of this guidance) and for bridge structures.

The understanding of carbon calculations for bridges is not as mature as that for buildings, however a Net Zero Bridges Group was formed in 2021, with a view to progress understanding in this area (for more information on the NZBG, contact: info@netzerobridges.org). As such, this information is provided with the expectation that it is likely to evolve in the future but is provided here to reflect the position at the time of publication.

Life cycle stages and modules

Life cycle stages broadly follow BS EN 15978⁵. However, for infrastructure projects including bridges, reference should be made to PAS 2080¹⁰. PAS 2080 introduces three additional life cycle modules for transport infrastructure (Figure 1.1b):

- Module A0 — Pre-construction stage — primarily office-based emissions associated with design, studies, consultations etc.
- Module B8 — Other operational processes
- Module B9 — Users' utilisation of infrastructure

Calculating embodied carbon

For a bridge, the minimum life cycle scope is Modules A1–A5. Additional commentary related to the minimum scope is defined in the following subsection.

Minimum scope: bridges

The relevant elements to include in the carbon assessment of bridges are summarised in Table C1. The minimum required elements are highlighted with shaded green cells. Some more traditionally civil elements are included as these commonly fall within the scope of the bridge designer and may have an appreciable impact on the carbon footprint of a bridge.

Inputs

Modules A1–A3 typically govern the structural embodied carbon of a bridge. However, when comparing infrastructure scheme options with varying bridge lengths and associated earthworks, Modules A4 and A5 emissions should not be neglected since the emissions associated with excavation, transport and fill onsite could be a major component in the total carbon footprint.

Material quantities

It is usually appropriate to consider the non-structural bridge elements, e.g. pavement and earthworks, when considering options at the concept stage.

Table C1: Bridge element categorisation

Element group	Element	Possible breakdown of structural elements for carbon analysis
Superstructure	Girder	Primary girder(s)
		Secondary members (cross-beams, bracing, etc.)
		Deck
	Truss	Truss
		Deck
	Cable system	Cable system
Substructure	Abutment	Foundations
		Abutment (incl. wingwalls but excl. foundations)
		Transition slab
	Pier	Foundations
		Columns
		Walls
		Beams
	Arch	Arch
	Pylon (can be in super- or substructure depending on arrangement)	Pylon
	Foundations	Shallow foundations
Deep foundations		Pile cap Piles
Ancillaries	Parapets	Structural parapets
	Expansion joints ^a	Expansion joints
	Bearings ^a	Bearings
	Roadway/walkway	Pavement
		Waterproofing
	Railway	Rails
		Sleepers
		Ballast
Drainage	Drainage	
Earthworks ^b	Excavation	Excavation
	Fill	Fill

Notes:

^a Where a suitable EPD is not available, approximation will usually suffice as these elements are not generally significant contributors to the overall carbon footprint.

^b It is important to define the scope of your assessment clearly. Most bridge schemes involve some earthworks, and those required to directly support the structure or integrate it into the terrain (e.g. excavation for foundation construction) should be accounted for wherever possible. However, on many infrastructure schemes there are major earthworks packages relating to associated approaches and cuttings. These are often best assessed separately as they may skew the assessment of the bridge structure on its own — but should always be reported as part of the overall carbon calculation process.

Inputs for A1 – A5 calculation

Modules A1–A3 carbon factors

In addition to the factors shown in Table 2.3, some relevant additional carbon factors to consider for bridges are summarised in Table C2.

Table C2: Suggested embodied carbon factors for bridge materials

Material	Type	Specification/details	Modules A1–A3 embodied carbon factor (kgCO ₂ e/kg)	Data source
Steel ^a	Cables	Assume the same as PT strands – adopting the worldwide average figure		
	Stainless	Worldwide average from the Institute for Stainless Steel Forum for most popular grade (304).	6.15	Ref. 19 (V2)
Asphalt	Road surface	Asphalt, 5% (bitumen) binder content (by mass)	0.065	Ref. 19
Waterproofing sealant	Epoxide resin		5.7	Ref. 19 (V2)
Aggregate (granular backfill)	General aggregate and sand	General UK: mixture of land-won, marine, secondary and recycled, bulk, loose	0.008	Ref. 19
		General worldwide: Aggregates and sand from virgin land-won resources, bulk, loose	0.004	

Note:

^a Where significant steelwork fabrication is required for steel plate, the additional embodied carbon associated with fabrication should be included, in addition to the embodied carbon factor to produce the plate itself.

Module A4 carbon factors

Bridge sites are typically more remote and less efficient logistically for the transport of large items. As a result, the empty return journey should be considered unless proven otherwise.

Module A5a carbon factors – site activities

For site activities it is suggested that specific calculations are carried out. This can be achieved using carbon factors for fuel consumption and time estimates from *Spon's Civil Engineering and Highway Works Price Book 2021*⁸⁶ or a similar cost/time/resource reference, or using specific carbon estimates included in texts such as *CESMM4*⁸⁷.

This is illustrated in Table C3 for the general case of excavation of firm sand and gravel for a depth of 2–5m.

Table C3: Example construction activity (A5a) embodied carbon factor calculation

Activity	Excavation of firm sand and gravel for maximum depth of 2–5m
Typical plant gang working time per unit	0.1hr/m ³ excavated
Diesel consumption for utilised plant	12.9l/hr
Effective diesel consumption	0.1 × 12.9 = 1.29l/m ³
Embodied carbon factor per m³ excavation	1.29 × 2.71 ^a = 3.50kgCO ₂ e/m ³
Note: ^a The UK emissions factor for diesel ⁶⁸ .	

Module A5w carbon factors — material wastage on site
Refer to section 2.2.4.1.

Module A5w carbon factors — temporary works

Bridges may be significantly influenced by the construction methodology, with different structural systems and arrangements potentially requiring very different temporary works.

Refer to Section 2.2.4.1.1. Temporary works items to consider include form travellers, erection gantries, launching noses, falsework[†], temporary foundations, temporary kingpost walls, temporary cables, trestles[†], crane pads etc.

When considering temporary works, there is generally significant cross-over with other members of the design team. The permanent works designer will not typically carry out the detailed design for temporary works but should have a good idea of the quantity required at an early stage.

Additional inputs for Modules A–C calculations

Additional information can be obtained from PAS 2080.

Module B9 Users utilisation of infrastructure

Module B9 is an important consideration, at least from a qualitative perspective, as the emissions associated with the traffic using the infrastructure ('user carbon', also referred to as UseCarb) can dwarf the capital carbon in some instances. Scenarios where it is considered appropriate to quantify the user carbon include:

- Where traffic staging during construction will lead to increased journey lengths (user carbon generated during construction should be included within Module A5 and shared with all works completed during a closure)
- Where maintenance, repair, replacement, or refurbishment require closure of the bridge leading to increased journey lengths. This may, for example, influence the selection of one repair option over another
- Where a proposed bridge is part of a wider transport route option assessment. For example, it could be misleading to neglect user carbon when comparing a design option with a longer bridge but a shorter overall route, to a shorter bridge within a longer overall route
- When comparing different transport mode options, e.g. light rail vs a highway

These will require input from a suitable traffic model to estimate the total additional journey lengths and traffic types associated with these scenarios. The traffic types should also account for anticipated future decarbonisation of users' modes of transport where appropriate.

[†] Generally, significant material reuse is possible.

Process

Normalising results

Normalise using the functional area of the deck (Section 2.3.2 and depicted in Figure C1).

Figure C1: Bridge deck functional area for normalising carbon estimates

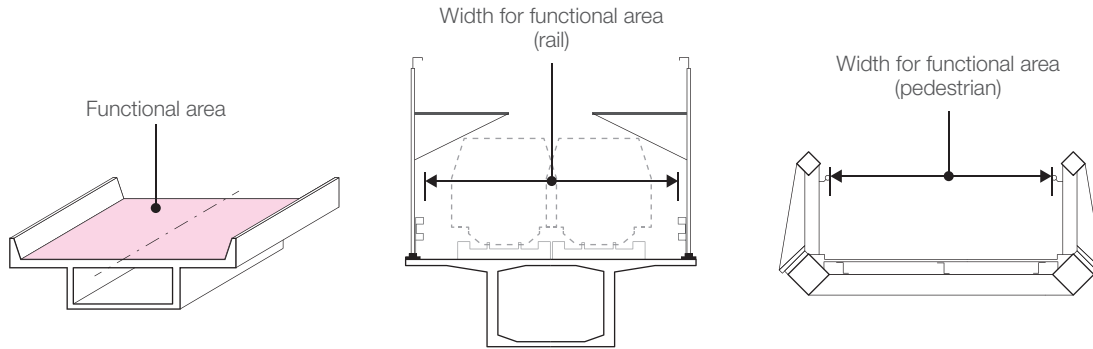

Outputs

The final carbon count should be uploaded to a shared database, such as the Built Environment Carbon Database⁸², to drive progress around industry understanding of carbon in bridges.

References

- 1 The Institution of Structural Engineers. *Climate emergency*. 2020. Available from: www.istructe.org/resources/climate-emergency/ [Accessed: March 2022].
- 2 The Institution of Structural Engineers. *The Structural Plan of Work 2020*. 2020. Available from: www.istructe.org/resources/guidance/the-structural-plan-of-work/ [Accessed: March 2022].
- 3 Elliott Wood Partnership Ltd and The Institution of Structural Engineers. *The Structural Carbon Tool*. 2021. Available from: <https://carbon.tips/tscl> [Accessed: March 2022].
- 4 Arnold W *et al.* *Setting carbon targets: an introduction to the proposed SCORS rating scheme*. 2020. Available from: [www.istructe.org/journal/volumes/volume-98-\(2020\)/issue-10/setting-carbon-targets-an-introduction-to-scors/](http://www.istructe.org/journal/volumes/volume-98-(2020)/issue-10/setting-carbon-targets-an-introduction-to-scors/) [Accessed: March 2022].
- 5 British Standards Institution. *BS EN 15978:2011: Sustainability of construction works. Assessment of environmental performance of buildings. Calculation method*. London: BSI, 2011.
- 6 British Standards Institution. *BS EN 15804:2012+A2:2019: Sustainability of construction works. Environmental product declarations. Core rules for the product category of construction products*. London: BSI, 2021.
- 7 RICS. *Whole life carbon assessment for the built environment (1st edition)*. 2017. Available from: <https://carbon.tips/rics> [Accessed: March 2022].
- 8 WGBC. *Advancing Net Zero Status Report 2020*. 2020. Available from: <https://carbon.tips/anz> [Accessed: March 2022].
- 9 Moynihan MC, Allwood JM. Utilization of structural steel in buildings. *Proceedings of the Royal Society A*. 2014;470(2168): doi.org/10.1098/rspa.2014.0170.
- 10 British Standards Institution. *PAS 2080:2016. Carbon management in infrastructure*. London: BSI, 2016.
- 11 LETI. *Embodied Carbon Primer*. 2020. Available from: <https://carbon.tips/leti> [Accessed: March 2022].
- 12 LETI, WLCN and RIBA. *Improving Consistency in Whole Life Carbon Assessment and Reporting*. 2021. Available from: <https://carbon.tips/consistency> [Accessed: March 2022].
- 13 Orr JJ *et al.* *Design for zero*. London: IStructE Ltd, 2021.
- 14 LETI. *Climate Emergency Design Guide*. 2020. Available from: <https://carbon.tips/leti> [Accessed: March 2022].
- 15 The Institution of Structural Engineers. *The Structural Engineer*. 2022. Available from: istructe.org/thestructuralengineer/ [Accessed: March 2022].
- 16 RICS. *Elemental Standard Form of Cost Analysis (4th edition)*. 2012. Available from: <https://carbon.tips/bcis> [Accessed: March 2022].
- 17 Poole I *et al.* *Seeing the bigger picture — industry emissions, your project and the performance gap*. 2021. Available from: [www.istructe.org/journal/volumes/volume-99-\(2021\)/issue-10/seeing-the-bigger-picture-industry-emissions/](http://www.istructe.org/journal/volumes/volume-99-(2021)/issue-10/seeing-the-bigger-picture-industry-emissions/) [Accessed: March 2022].
- 18 Cobb F. *Structural Engineer's Pocket Book: Eurocodes*. London: Taylor & Francis, 2014.
- 19 Circular ecology. *The Inventory of Carbon and Energy (The ICE Database)*. 2020. Available from: <https://carbon.tips/ice3> [Accessed: March 2022].
- 20 Building Transparency. *Embodied Carbon in Construction Calculator (EC3)*. 2022. Available from: <https://carbon.tips/ec3> [Accessed: March 2022].
- 21 British Precast Flooring Federation. *Environmental Product Declaration (EPD): UK manufactured precast hollowcore flooring*. 2017. Available from: <https://carbon.tips/hollow> [Accessed: March 2022].
- 22 UK CARES. *Environmental Product Declaration: Carbon Steel Reinforcing Bar (secondary production route — scrap), Sector Average*. 2020. Available from: <https://carbon.tips/u5e> [Accessed: March 2022].
- 23 World Steel Association. *Life cycle inventory (LCI) study: 2020 data release*. 2021. Available from: <https://worldsteel.org/wp-content/uploads/Life-cycle-inventory-LCI-study-2020-data-release.pdf> [Accessed: March 2022].
- 24 Stahl Gerlafingen. *Environmental Product Declaration: Rebar Topar-RC stretched coil manufactured in Gerlafingen*. 2018. Available from: www.environdec.com/library/epd1086 [Accessed: March 2022].
- 25 Pacific Steel. *Environmental Product Declaration: UN CPC 4124 — Bars and rods, hot-rolled, of iron or steel. ANZSIC C2210 — Iron Smelting and Steel Manufacturing*. 2018. Available from: www.pacificsteel.co.nz/assets/Uploads/EPD-Pacific-Steel-SEISMIC-reinforcing-bar-coil-rod-and-wire-Copy.pdf [Accessed: March 2022].

- 26 BSCA/Steel for Life/SCI. *UK average embodied carbon of structural steel*. Available from: www.newsteelconstruction.com/wp/wp-content/uploads/digi/NSCApr2021digi.pdf#page=25 [Accessed: March 2022].
 - 27 Aenor Confia. *Environmental Product Declaration: Long products of hot rolled structural non-alloy steel coming from electric furnace: steel sections for structural use; steel bars and sections for general use*. 2013. Available from: www.aenor.com/Producto_DAP_pdf/GlobalEPD_001_003_04_r1_EN.pdf [Accessed: March 2022].
 - 28 British Steel. *Environmental Product Declaration: Steel Rails and Sections (including semi-finished long products)*. 2020. Available from: <https://carbon.tips/rails> [Accessed: March 2022].
 - 29 TATA Steel. *Environmental Product Declaration: Structural hollow sections*. 2017. Available from: <https://carbon.tips/tatashs> [Accessed: March 2022].
 - 30 TATA Steel. *Environmental Product Declaration: ComFlor[®] 80 0.9mm steel structural floor deck*. 2021. Available from: www.tatasteleurope.com/sites/default/files/Tata%20Steel%20EPD%20ComFlor%2080%200.9mm%20052021.pdf [Accessed: March 2022].
 - 31 TATA Steel. *Environmental Product Declaration: ComFlor[®] 51⁺ 0.9mm steel structural floor deck*. 2021. Available from: www.tatasteleurope.com/sites/default/files/Tata%20Steel%20EPD%20ComFlor%2051%2B%200.9mm%20052021.pdf [Accessed: March 2022].
 - 32 TATA Steel. *Environmental Product Declaration: ComFlor[®] 60 1.0mm steel structural floor deck*. 2021. Available from: www.tatasteleurope.com/sites/default/files/Tata%20Steel%20EPD%20ComFlor%2060%201.0mm.pdf [Accessed: March 2022].
 - 33 Historic Scotland. *Technical Paper 7: Embodied Carbon in Natural Building Stone in Scotland*. 2010. Available from: www.historicenvironment.scot/archives-and-research/publications/publication/?publicationId=8c3ebef1-ba50-40cb-ab75-a59400e2b74b [Accessed: March 2022].
 - 34 Place T, Perkins C, Caine L. *Mass timber embodied carbon factors*. 2021. Available from: www.istructe.org/resources/blog/mass-timber-embodied-carbon-factors/ [Accessed: March 2022].
 - 35 Division Wood Products. *Environmental Product Declaration: CLT (Cross Laminated Timber)*. 2020. Available from: www.storaenso.com/-/media/documents/download-center/certificates/wood-products-approvals-and-certificates/epd/stora-enso-epd-clt-2021.pdf [Accessed: March 2022].
 - 36 Wood for Good. *Lifecycle database: Cross Laminated Timber*. 2013. Available from: https://woodforgood.com/assets/Downloads/CLT_v1.2_2014-03-18.pdf [Accessed: March 2022].
 - 37 epd-norge. *Environmental Product Declaration: Glulam beams and pillars*. 2018. Available from: www.epd-norge.no/heltreprodukter/glulam-beams-and-pillars-article1967-320.html [Accessed: March 2022].
 - 38 J.F. Amonn S.r.l. *Environmental Product Declaration: Intumescent Coating*. 2019. Available from: www.environdec.com/library/epd1434 [Accessed: March 2022].
 - 39 Isolatek International. *Transparency report: CAFCO[®]; 300*. 2019. Available from: www.transparencycatalog.com/company/isolatek-international/showroom/cafco-300-hs/lca-results [Accessed: March 2022].
 - 40 Isolatek International. *Transparency report: CAFCO[®]; 400*. 2019. Available from: www.transparencycatalog.com/company/isolatek-international/showroom/cafco-400 [Accessed: March 2022].
 - 41 Isolatek International. *Transparency report: CAFCO[®]; BLAZE-SHIELD[®]; II*. 2019. Available from: www.transparencycatalog.com/company/isolatek-international/showroom/cafco-blaze-shield-ii [Accessed: March 2022].
 - 42 Isolatek International. *Transparency report: CAFCO[®]; FENDOLITE[®]; M-II*. 2019. Available from: www.transparencycatalog.com/company/isolatek-international/showroom/cafco-fendolite-m-ii [Accessed: March 2022].
 - 43 MPA The Concrete Centre. *Concrete Industry Sustainability Performance Report (13th report: 2019 performance data)*. 2021. Available from: https://sustainableconcrete.org.uk/MPA-ACP/media/SustainableCon-Media-Library/Pdfs%20-%20Performance%20reports/SCF_13thPerformanceReport_Oct21.pdf [Accessed: March 2022].
 - 44 Carbon Leadership Forum. *Embodied carbon in the EC3 tool: beta methodology report*. 2019. Available from: <https://carbon.tips/methodology> [Accessed: March 2022].
 - 45 International Standards Organization. *ISO 21930:2007: Sustainability in building construction – Environmental declaration of building products*. Geneva: ISO, 2007.
 - 46 ASBP. *ASBP Briefing Paper: December 2019*. 2019. Available from: <https://carbon.tips/asbp1> [Accessed: March 2022].
-

- 47 ASBP. *ASBP Briefing Paper: January 2020*. 2020. Available from: <https://asbp.org.uk/briefing-paper/epd-how-to-use> [Accessed: March 2022].
- 48 Lorenz E. How to read an EPD: basics for the structural engineer. *The Structural Engineer*. 2021. Available from: [istructe.org/journal/volumes/volume-99-\(2021\)/november-december-2021/how-to-read-an-epd-basics-for-structural-engineer/](http://istructe.org/journal/volumes/volume-99-(2021)/november-december-2021/how-to-read-an-epd-basics-for-structural-engineer/) [Accessed: March 2022].
- 49 UN Environment. Eco-efficient cements: Potential economically viable solutions for a low-CO₂ cement-based materials industry. *Cement and Concrete Research*. 2018;114: 2–26.
- 50 Lehne J, Preston F. *Making Concrete Change: Innovation in Low-carbon Cement and Concrete*. London: Chatham House. 2018. Available from: <https://carbon.tips/mcc> [Accessed: March 2022].
- 51 Allwood J. *et al. Absolute zero: Delivering the UK's climate change commitment with incremental changes to today's technologies*. Cambridge: UKFIRES. 2019. Available from: <http://carbon.tips/zero> [Accessed: March 2022].
- 52 Low Carbon Concrete Group/Green Construction Board. *Low Carbon Concrete Routemap: Setting the agenda for a path to net zero*. 2022. Available from: constructionleadershipcouncil.co.uk/wp-content/uploads/2021/12/LCCG_Publication_DRAFT_FOR_CONSULTATION_V2.pdf [Accessed: March 2022].
- 53 Purnell P, Black L. Embodied carbon dioxide in concrete: Variation with common mix design parameters. *Cement and Concrete Research*. 2012;42(6): 874–877.
- 54 Anderson J, Moncaster A. Embodied carbon of concrete in buildings, Part 1: analysis of published EPD. *Buildings and Cities*. 2020;1(1): 198–217. Available from: <http://doi.org/10.5334/bc.59> [Accessed: March 2022].
- 55 BRMCA. Cement type/early age properties. *Concrete Today*. Available from: <https://carbon.tips/brmca> [Accessed: March 2022].
- 56 MPA. *Specifying Sustainable Concrete: Understanding the role of constituent materials*. 2020. Available from: <https://carbon.tips/mpa> [Accessed: March 2022].
- 57 Circular ecology. *Concrete Embodied Carbon Footprint Calculator*. 2020. Available from: <https://carbon.tips/ccalc> [Accessed: March 2022].
- 58 World Steel Association. *Fact sheet: Steel and raw materials*. 2019. Available from: <https://carbon.tips/wsa> [Accessed: March 2022].
- 59 British Standards Institution. *BS EN 16449:2014: Wood and wood-based products. Calculation of the biogenic carbon content of wood and conversion to carbon dioxide*. London: BSI; 2014.
- 60 British Standards Institution. *BS EN 16485:2014: Round and sawn timber. Environmental Product Declarations. Product category rules for wood and wood-based products for use in construction*. London: BSI; 2014.
- 61 British Standards Institution. *BS EN 15804:2012+A1:2013: Sustainability of construction works. Environmental product declarations. Core rules for the product category of construction products*. London: BSI; 2012.
- 62 Hart J, Pomponi F. More timber in construction: Unanswered questions and future challenges. *Sustainability*. 2020;12(8): <https://doi.org/10.3390/su12083473>.
- 63 Ramage MH *et al.* The wood from the trees: The use of timber in construction. *Renewable and Sustainable Energy Reviews*. 2017;68(1): <https://doi.org/10.1016/j.rser.2016.09.107>.
- 64 HM Government. *Greenhouse gas reporting: conversion factors 2021*. 2021. Available from: <https://carbon.tips/cf2021> [Accessed: March 2022].
- 65 WRAP. *Net Waste Tool*. Available from: <https://carbon.tips/nwtool> [Accessed: March 2022].
- 66 Campbell A, Hairstans R, Jones G. Refocusing modern methods of construction on the climate emergency: a 'five capitals' model for action. *The Structural Engineer*. 2020. Available from: www.istructe.org/|StructE/media/Public/TSE-Archive/2020/Refocusing-modern-methods-of-construction-on-the-climate-emergency-a-5-capitals-model.pdf [Accessed: March 2022].
- 67 RICS. *Code of measuring practice (6th edition)*. 2015. Available from: <https://carbon.tips/comp> [Accessed: March 2022].
- 68 BRE. *Environmental Product Declaration: 1kg of kiln dried planed or machined sawn timber used as structural timber*. 2017. Available from: <https://carbon.tips/000504> [Accessed: March 2022].
- 69 TRADA. *WIS 2/3-59: Recovering and minimising waste wood*. Available from: www.trada.co.uk/publications/wood-information-sheets/recovering-and-minimising-waste-wood/ [Accessed: March 2022].
- 70 Wood for Good. *Lifecycle Database: Kiln Dried Sawn Softwood*. 2013. Available from: <https://carbon.tips/wfg> [Accessed: March 2022].
- 71 The Concrete Centre. *TCC/05/30: Whole-life Carbon and Buildings*. London: MPA The Concrete Centre, 2016.
- 72 Ellen MacArthur Foundation. *What is a circular economy?* 2017. Available from: <https://carbon.tips/ema> [Accessed: March 2022].

- 73 BSRIA. *Designing Buildings Wiki: Circular economy in the built environment*. 2021. Available from: <https://carbon.tips/dbc> [Accessed: March 2022].
- 74 Institut Bauen und Umwelt e.V (IBU). *Environmental Product Declaration: UK manufactured generic ready-mixed concrete*. 2018. Available from: <https://carbon.tips/mpa1> [Accessed: March 2022].
- 75 Brütting J. *et al.* Optimum Design of Frame Structures From a Stock of Reclaimed Elements. *Frontiers in Built Environment*. 2020; 6(57):1–18. Available from: <http://doi.org/10.3389/fbuil.2020.00057> [Accessed: March 2022].
- 76 Bukauskas A. *et al.* Inventory-constrained structural design: new objectives and optimization techniques. *Proceedings of IASS 2018 Boston Symposium: Environmentally Compatible Structures*. Available from: https://people.bath.ac.uk/ps281/research/publications/boston_preprint3.pdf [Accessed: March 2022].
- 77 UKGBC. *Circular Economy How-to Guide: Reusing products and materials in built assets*. 2020. Available from: <https://carbon.tips/circular> [Accessed: March 2022].
- 78 Kaethner S, Burridge J. Embodied CO₂ of structural frames. *The Structural Engineer*. 2012;90(5); 33–40. Available from: [www.istructe.org/journal/volumes/volume-90-\(2012\)/issue-5/embodied-co2-of-structural-frames/](http://www.istructe.org/journal/volumes/volume-90-(2012)/issue-5/embodied-co2-of-structural-frames/) [Accessed: March 2022].
- 79 Cundall. *Information Paper 12: Embodied carbon case studies for office buildings*. 2013. Available from: <https://carbon.tips/eccs> [Accessed: March 2022].
- 80 Archer-Jones C, Green D. Carbon targets for bridges: a proposed SCORS-style rating scheme. *The Structural Engineer*. 2021;99(10); 14–18. Available from: [www.istructe.org/journal/volumes/volume-99-\(2021\)/issue-10/carbon-targets-for-bridges-proposed-rating-scheme/](http://www.istructe.org/journal/volumes/volume-99-(2021)/issue-10/carbon-targets-for-bridges-proposed-rating-scheme/) [Accessed: March 2022].
- 81 IPCC. *Special Report: Global Warming of 1.5°C*. 2018. Available from: www.ipcc.ch/sr15/ [Accessed: March 2022].
- 82 BECD. *November 2021: Launch of Built Environment Carbon Database (BECD)*. 2021. Available from: www.becd.co.uk/ [Accessed: March 2022].
- 83 Qflow. *Data driven sustainability*. 2020. Available from: <https://carbon.tips/qflow> [Accessed: March 2022].
- 84 The Institution of Structural Engineers. *Structural engineers declare climate and biodiversity emergency*. 2020. Available from: www.istructe.org/structural-engineers-declare/ [Accessed: March 2022].
- 85 European Commission. *Level(s) — A common EU framework of core sustainability indicators for office and residential buildings: Parts 1 and 2, introduction to level(s) and how it works*. 2017. Available from: <https://op.europa.eu/en/publication-detail/-/publication/f3c2fc97-f102-11e7-9749-01aa75ed71a1/language-en> [Accessed: March 2022].
- 86 AECOM (Ed.) *Spon's Civil Engineering and Highway Works Price Book 2021*. Boca Raton, FL: CRC Press; 2020.
- 87 ICE Publishing. *CESMM4: Civil Engineering Standard Method of Measurement, Fourth edition, revised*. London: Thomas Telford Ltd.; 2019.
- 88 UK Government. *Greenhouse gas reporting: conversion factors 2021*. Available from: www.gov.uk/government/publications/greenhouse-gas-reporting-conversion-factors-2021 [Accessed: March 2022].
-

How to calculate embodied carbon

This guide provides a common set of embodied carbon calculation principles for the structural engineering community to follow. The imperative to achieve net zero carbon by 2050 must change the way we practice — and calculating carbon is a key part of this.

Calculating embodied carbon in the same rigorous way across all designs will allow meaningful comparisons to be made between structural schemes, developing our understanding of embodied carbon as well as how we can most effectively reach net zero carbon. This guidance is equally applicable to infrastructure and building projects.

For this second edition (2022) the table of Module A1–A3 (production stage) carbon factors has been fully updated, and now includes suggested upper and lower bound values to enable engineers to better understand the level of certainty in their calculations. New recommendations for steel and timber carbon factors (reflecting 2021 research undertaken by BCSA and Arup respectively) are presented. Emissions due to timber structures are more fully explained (highlighting the difference between biogenic carbon and fossil emissions, and more closely aligning with standards). In addition, two new appendices — a worked example, and high-level guidance specific to the calculation of embodied carbon in bridges — have been included.

References to embodied carbon data and guidance are UK-focused. Where the authors are aware of such information from other countries, it is referenced in Appendix A. This document is aligned with BSEN 15978, BSEN 15804 and RICS Professional Statement *Whole life carbon assessment for the built environment*. The guidance also supports the sustainability related core tasks in *The Structural Plan of Work 2020*.

The Institution of StructuralEngineers

The Institution of Structural Engineers
International HQ
47–58 Bastwick Street
London, EC1V 3PS
United Kingdom

T: +44 (0)20 7235 4535
E: mail@istructe.org
W: www.istructe.org

Registered with the Charity Commission
for England and Wales No. 233392 and
in Scotland No. SC038263

